

Classic<sup>TM</sup>roof  
by Ultraframe

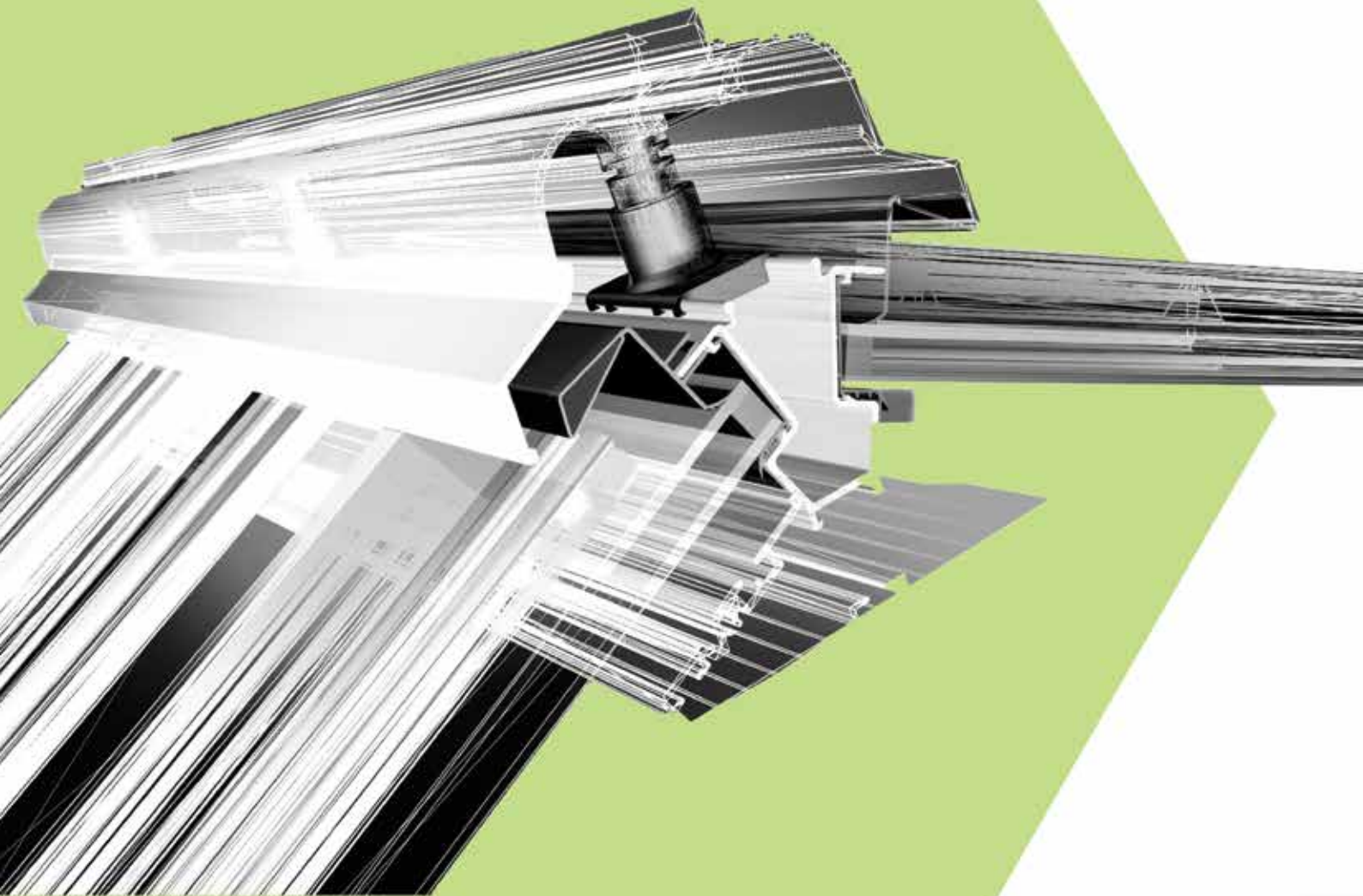

V7 | July 2020

PRODUCT DIRECTORY

# DIRECTORY – Overview

This guide is a 'snap shot' of the core elements of the Classic roof

## SECTION 1 - Eaves

Pages 3-13

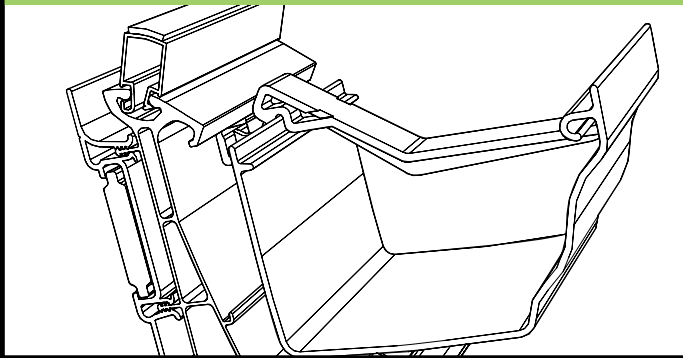

## SECTION 2 - Ridge

Page 14-23

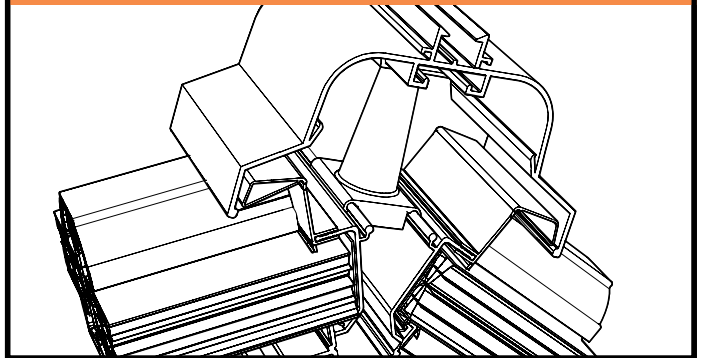

## SECTION 3 - Glazing Bars

Pages 24-29

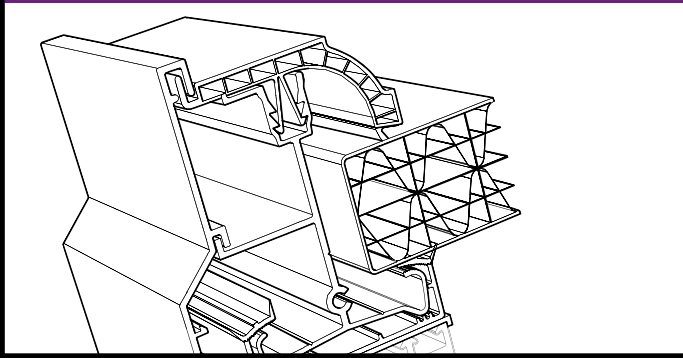

## SECTION 4 - Valley

Pages 30-31

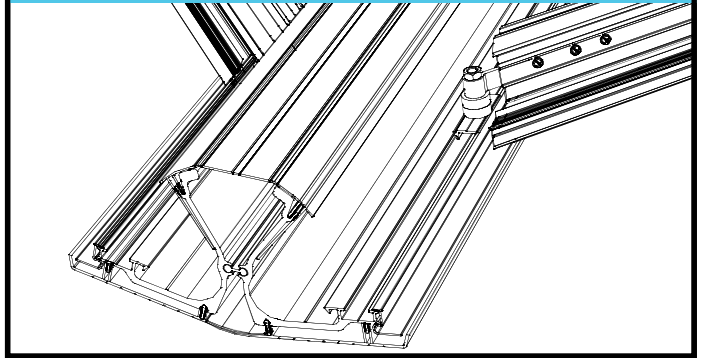

## SECTION 5 - Guttering

Pages 32-37

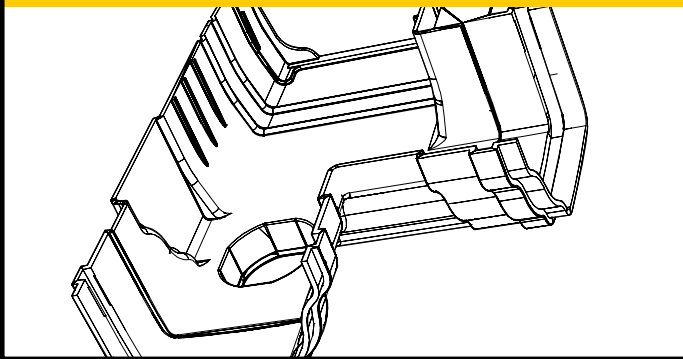

## SECTION 6 - Ancillaries

Pages 38-41

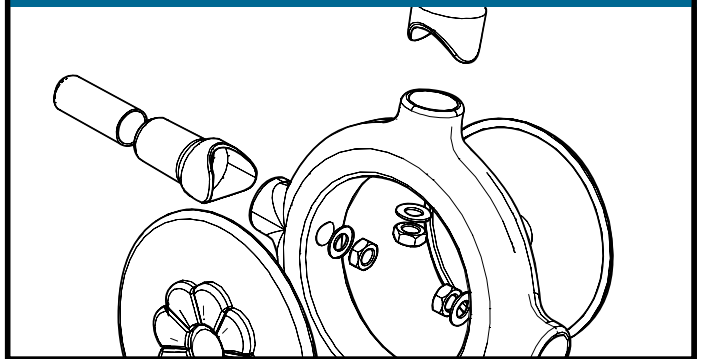

## SECTION 7 - Boxgutter Adaptors

Page 42-43

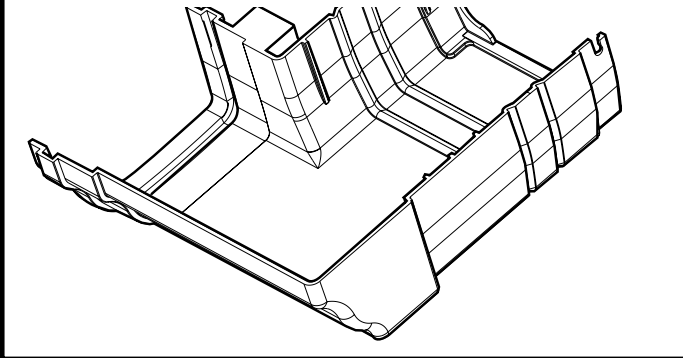

## SECTION 8 - Rainwater Outlets

Page 44

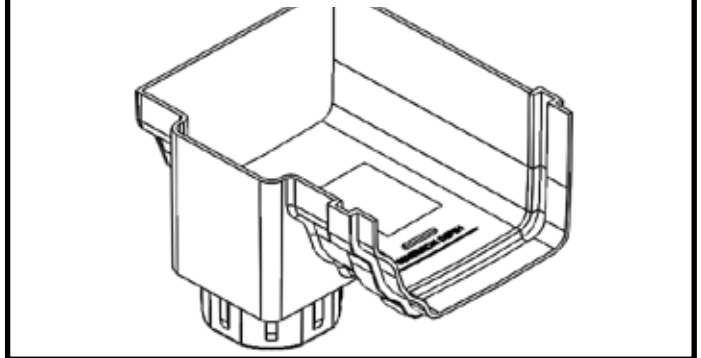

# SECTION 1 - Eaves

The starting point for any roof system, as it attaches to the top of the side frames

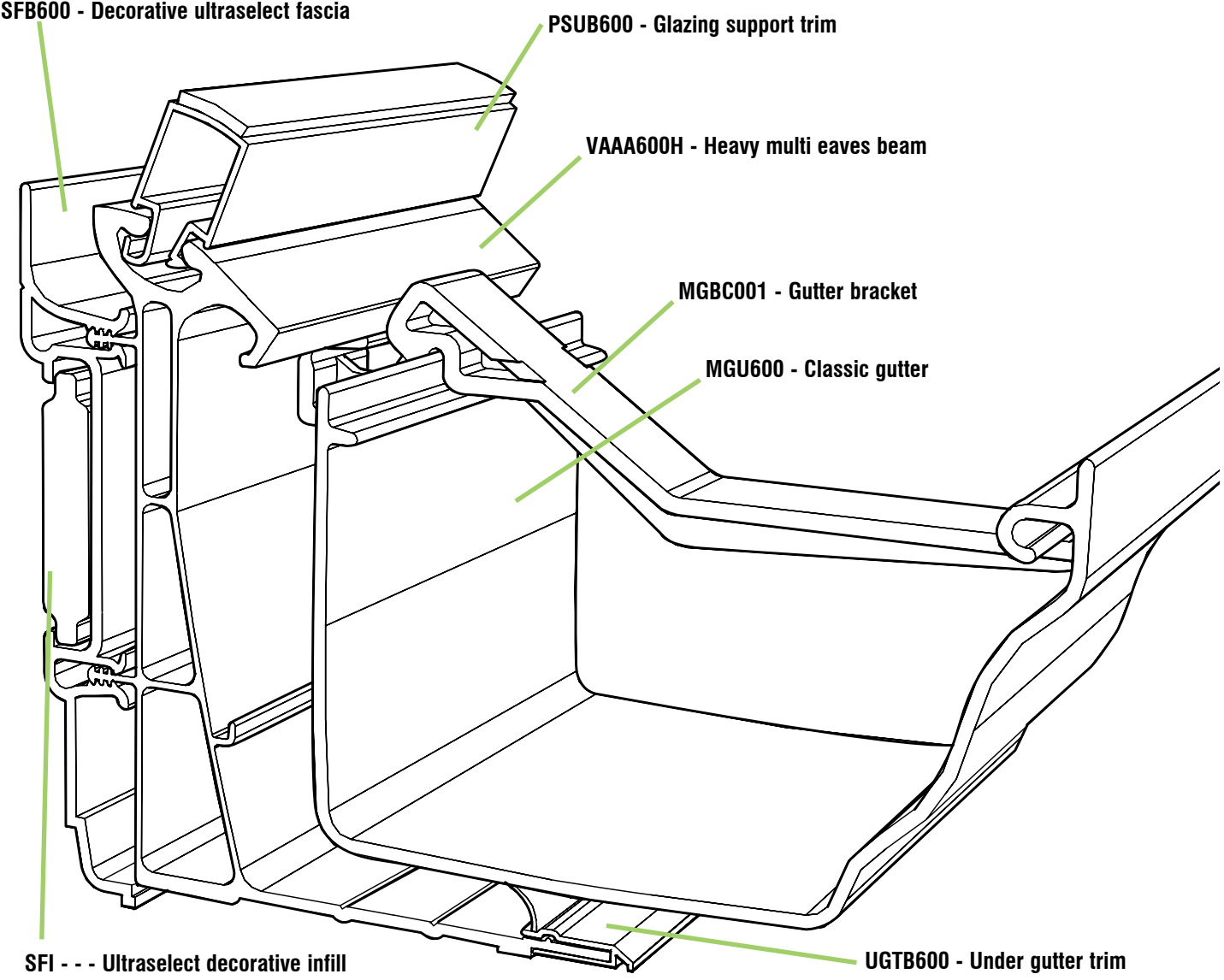

**SFI - - - Ultraselect decorative infill**  
See page 8 for details.  
or  
Plain infil SNP on p9

**AGP - - - Glazing End Profile**

AGP---/25 GLAZING END PROFILE



**DTM - - - Dentil Moulding**

DTM002 DENTIL MOULDING CLIP FIT  
DTM004 DENTIL MOULDING ADHESIVE FIX

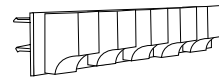

**DFCA - - - Decorative Fascia Jointers/ Corners**

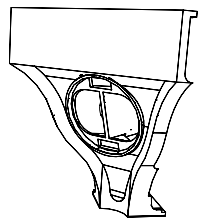

DFCA001 INLINE JOINTER  
DFCA090A ADJUSTABLE CORNER  
DFCA090I 90 DEGREE INTERNAL CORNER  
DFCA135 135 DEGREE CORNER  
DFCA150 150 DEGREE CORNER

**EBCA - - - Eaves Beam Connecting Cleats**

EBCA001 CLEAT INLINE  
EBCA090 CLEAT 90 DEGREE  
EBCA135 CLEAT 135 DEGREE  
EBCA150 CLEAT 150 DEGREE

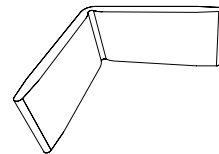

**DCM 001 Insert for Decorative Fascia Corners**

DCM001 INSERT FOR DEC FASCIA CORNERS

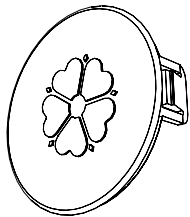

**EBT 001 Eaves Beam Cleat Taptite Screw**

EBT001 EAVES BEAM CLEAT TAPTITE M5 x12

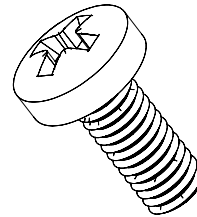

**DCM 001 Insert for Decorative Fascia Corners**

DCM001/WV INSERT FOR DEC FASCIA CORNERS



**EECA - - - Eaves Beam End Plug**

EECA001S/L EAVES BEAM END PLUG LEFT  
EECA001S/R EAVES BEAM END PLUG RIGHT

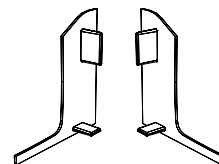

**DFS 650/2 Trim to Front of Super Duty Eaves Beam**

DFS650/2 TRIM TO FRONT OF SUPER DUTY EAVES BEAM



**EFSA 021 End Cap Fixing Kit (20)**

EFSA 021 END CAP FIXING KIT (20)

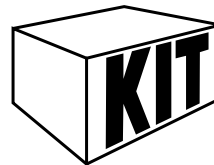

**DTA - - - Dentil add on Profile**

DTA600 DENTIL ADD ON 58-64MM FRAMES  
DTA600L DENTIL ADD ON 65-70MM FRAMES

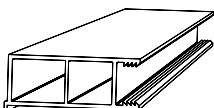

**ETV 001 Eaves Ventilator**

ETV001 EAVES VENTILATOR



**FIR - - -**      **Firring Top Cap (Used with LCTB)**

---

FIR/2NT      FIRRING TOP CAP  
(USED WITH LCTB)



**GBR- - -**      **Gable Beam Reinforcement**

---

GBR500      GABLE BEAM REINFORCEMENT 5M  
GBR650      GABLE BEAM REINFORCEMENT 6.5M

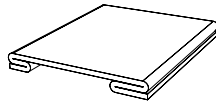

**FLN 001**      **Flange Nut (7mm Holes)**

---

FLN001      FLANGE NUT(7mm HOLES)



**GEC - - -**      **Gable Beam Top Cladding**

---

GEC650      GABLE BEAM TOP CLADDING 6.5M

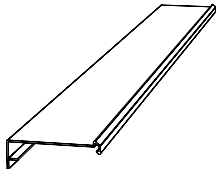

**FLNS 001**      **Spigot Nut (9mm Holes)**

---

FLNS001      SPIGOT NUT (9mm HOLES)



**GIE - - -**      **Gable Infill Wedge End Cap**

---

GIE001      GABLE INFILL WEDGE END CAP

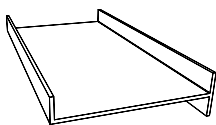

**GAC 001**      **Gable Eaves Beam Corner**

---

GAC001L      CORNER LEFT(BOLT SLOT RETURN)  
GAC001R      CORNER RIGHT(BOLT SLOT RETURN)

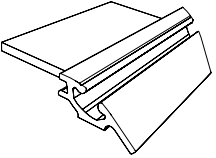

**LCP - - -**      **Low Pitch Lean to Eaves End Cap Block**

---

LCP001L      LOW PITCH LEAN TO EAVES END  
CAP BLOCK LEFT  
LCP001R      LOW PITCH LEAN TO EAVES END  
CAP BLOCK RIGHT



**GBE - - -**      **Aluminium Gable Beam**

---

GBE400      ALUMINIUM GABLE BEAM 4M  
GBE650      ALUMINIUM GABLE BEAM 6.5M

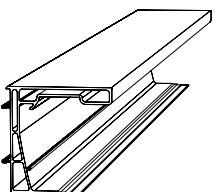

**LHEA - - -**      **Lantern Header Beam**

---

LHEA600      LANTERN HEADER BEAM  
LHEA600\_/1      LANTERN INTERNAL FASCIA TRIM  
LHEA600\_/2      LANTERN EXTERNAL FASCIA TRIM



**GBIA - - -**      **Gable Infill Wedge**

---

GBIA010      GABLE INFILL WEDGE - 10°  
GBIA0125      GABLE INFILL WEDGE - 12.5°  
GBIA015      GABLE INFILL WEDGE - 15°  
GBIA020      GABLE INFILL WEDGE - 20°  
GBIA025      GABLE INFILL WEDGE - 25°  
GBIA030      GABLE INFILL WEDGE - 30°  
GBIA035      GABLE INFILL WEDGE - 35°  
GBIA040      GABLE INFILL WEDGE - 40°

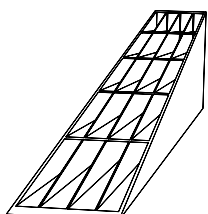

**PCF - - -**      **Glazing End Profile Trim**

---

PCFD/24      END PROFILE TRIM (24MM)  
PCFD/35      END PROFILE TRIM (35MM)



**PFCA - - - V Groove Fascia Jointers/Corners**

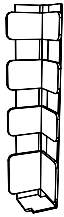

- PFCA001 JOINT INLINE
- PFCA090E 90 DEG EXTERNAL
- PFCA290V 90 DEG INTERNAL CORNER
- PFCA135V 135 DEG INTERNAL CORNER
- PFCA150 150 DEG INTERNAL CORNER

**SAB 001 Anchor Bolt - Used on TBRK**

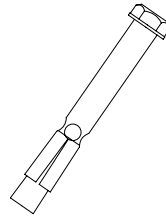

- SAB001 BOX GUTTER BOLT M8 X 80MM
- SAB002 BOX GUTTER BOLT M6 X 65MM

**PFTC - - - V Groove fascia**

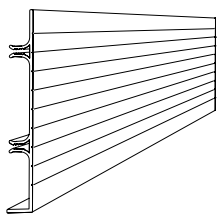

- PFTC600V FASCIA CLADDING 6M

**SEBA 600/1 Structural Eaves Beam**



- SEBA600/1 STRUCTURAL EAVES BEAM 6M

**PST - - - Glazing Support Trim (Punched)**

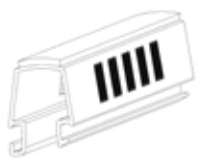

- PST003 TRIM 1600MM PUNCHED
- PST004 TRIM 950MM PUNCHED

(USED IN CONJUNCTION WITH ETV001)

**SEB 001 Splice Plate - Structural Eaves Beam**



- SEB001 SPLICE PLATE- STRUCTURAL EAVES BEAM

**PSUB - - - Glazing Support Trim**

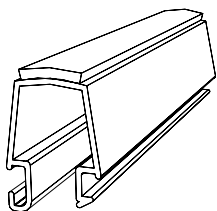

- PSUB600 SUPPORT TRIM 6M

**SEB 002 Eaves End Cap**



- SEB002L EAVES END CAP LEFT
- SEB002R EAVES END CAP RIGHT

**RES 001 Gable Eaves Corner Screw**

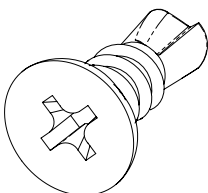

- RES001 GABLE EAV CORNER SCREW 3.9 X 16 (C/SK HEAD SELD DRILL SCREW)

(ALSO USED FOR SECURING REINFORCING IN GABLE HEAD)

**SEB 003 Fascia Inline Joint**



- SEB003L FASCIA INLINE JOINT LEFT
- SEB003R FASCIA INLINE JOINT RIGHT

(FASCIA TO BOX GUTTER)

**RS3510 M6 x 20mm Bolt for Low Pitch Eaves**

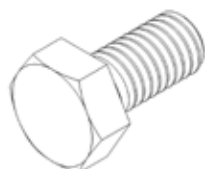

- RS3510 M6 x 20mm Bolt for Low Pitch Eaves ONLY

**SES 001 90° Butterfly Strap (TBRK)**

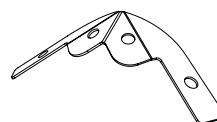

- SES001 90° BUTTERFLY STRAP

**SEB550 - -/3**

**Bolster Male Cladding**

SEB550--/3 BOLSTER MALE CLADDING

(SITS UNDER SUPER DUTY EAVES BEAM)

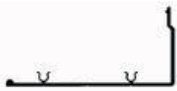

**SES 002**

**Inline Cleat (TBRK)**

SES002 INLINE CLEAT

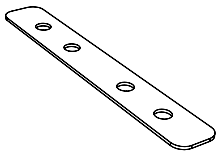

**SES 003**

**Inline Cleat (with transom) (TBRK)**

SES003 INLINE CLEAT (WITH TRANSOM)

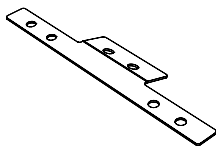

**SES 004**

**135° Butterfly Strap (TBRK)**

SES004 135° BUTTERFLY STRAP

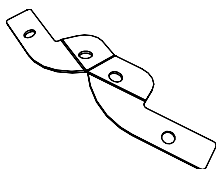

**SES 005**

**165 Box Gutter Strap (TBRK)**

SES005L LEFT HAND BRACKET  
SES005R RIGHT HAND BRACKET

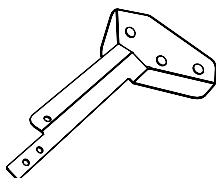

**SES 006**

**265 Box Gutter Strap (TBRK)**

SES006L LEFT HAND BRACKET  
SES006R RIGHT HAND BRACKET

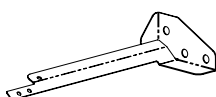

**SEWC 001**

**Aluminium Eaves Moulding (TBRK)**

SEWC001L LEFT HAND EAVES WALL CLEAT  
SEWC001R RIGHT HAND EAVES WALL CLEAT  
(Pictured)

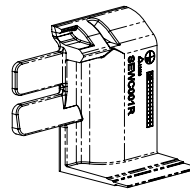

**SFB - - -**

**Decorative Ultraselect Fascia**

SFB600 DEC SELECT FASCIA BOARD

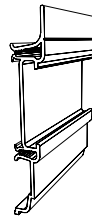

**SFI - - -**

**Decorative Ultraselect Infills**



SF1003 - Tapestry

SF1003K

SF1003G

**SFS 001**

**M6 X 16 TapTite- Splice Plate**

SFS001 M6 x 16 TAPTITE- SPLICE PLATE



**SHBC - - -**

**Glazing Bar Fixing Bolts**

SHBC001S SINGLE BOLT 21.5mm LONG  
SHBC001SL SINGLE BOLT 30mm LONG  
SHBC001T TWIN BOLT ASSEMBLY 21.5mm LONG  
SHBC050S SINGLE BOLT 21.5 & NUT (BAG OF 50)

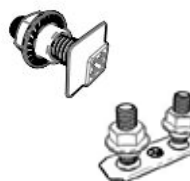

**SNP - - -**

**Decorative Ultraselect Plain Fascia Infill**

SNP600 DEC FASCIA PLAIN INFIL

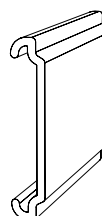

**TBW 002**

Washer Used with SHBC001SL



TBW002 WASHER  
(USED WITH SHBC001SL)

**UZRI 010**

Eaves Moulding Fixing (TBRK)

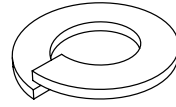

UZRI010/5 EAVES MOULDING STARTER FIXING  
M8 SINGLE COILED SPRING

(USE WITH VRK004/1)

**UGTB - - -**

Under Gutter Trim

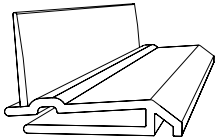

UGTB600 UNDER GUTTER TRIM 6M

**VAAA600H**

Eaves Beam

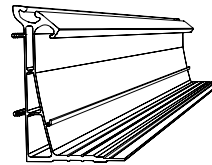

VAAA600H MULTI EAVES BEAM 6M

**UZBGF 001**

Butterfly Cleat Screw (TBRK)

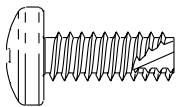

UZBGF001 BUTTERFLY CLEAT SCREW 6 X 16  
  
(ALSO USED FOR INLINE CLEATS OR  
BOX GUTTER STRAPS)

**VFK - - -**

Victorian Fixing Kit

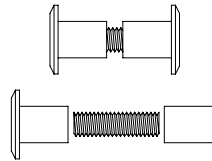

VFK001 VICTORIAN FIXING KIT  
17 x Small(22mm) & 3 x Large(37mm)  
VFK002 VICTORIAN FIXING KIT  
20 x Large(37mm)

**UZLPEB/ -**

Low Pitch Eaves Beam



UZLPEB/1 LOW PITCH EAVES BEAM  
UZLPEB/2 EAVES INNER BOTTOM TRIM  
UZLPEB/3 EAVES EXTERNAL CLADDING  
UZLPEB/4 INTERNAL FASCIA CLADDING

**VLPB 001/1**

Eaves Beam high and Low Pitch Packer

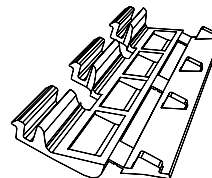

VLPB001 TRANSOM BAR PACKER (BLACK)

**UZLPEJ001**

Sleeve to Join Inline Low Pitch Eaves Beam

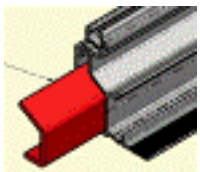

UZLPE001 SLEEVE TO JOIN INLINE EAVES

**VRK 004/1**

Eaves Moulding Starter Fixing (TBRK)

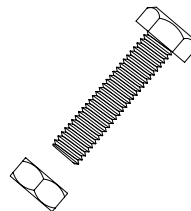

VRK004/1 EAVES MOULDING STARTER FIXING  
M8 X 35 BOLT AND NUT

(USE WITH UZRI 010)

**UZLPFR/1**

UZLPFR/1 FIRRING MAIN BODY



**UZLPFR/2**

UZLPFR/2 FIRRING BASE (SITS ON FRAME)





**UZLPFR/4**

UZLPFR/5 ALUMINIUM REINFORCEMENT



**UZLPFR/6**

UZLPFR/6 STEEL REINFORCEMENT



**UZLPFR/5**

UZLPFR/5 ALUMINIUM REINFORCEMENT



**SECTION 1.1 - Cornice**

**CRN---/1 Lower Cornice Section**

CRN---/1 LOWER CORNICE SECTION  
(USED WITH STANDARD  
EAVES BEAM)



**CRN---/4 SEB Cornice Trim**

CRN---/4 SEB Cornice Trim



**CRN---/2 Middle Cornice Section**

CRN---/2 MIDDLE CORNICE SECTION



**CRN---/5 External Cornice Extension**

CRN---/5 EXTERNAL CORNICE EXTENSION



**CRN---/3 Upper Cornice Section**

CRN---/3 UPPER CORNICE SECTION



**CRN001 Cleat**

CRN001 CLEAT (CONNECTING CORNICE  
CORNERS)

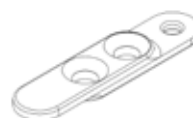

**CRN002 Support Bracket**

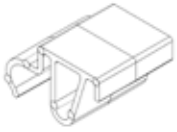

CRN002 SUPPORT BRACKET - CORNICE GUTTER

**CRN010 Tie Wire Screw**



CRN010 TIE WIRE SCREW

**CRN003 Gable/Lean To End Plate**



CRN003 GABLE/LEAN TO END PLATE - CORNICE

**CRN014 Cornice Inline Outlet Cover**



CRN014 CORNICE INLINE OUTLET COVER

**CRN00- TIE WIRE**



CRN005 TIE WIRE (USED OFF TRANSOM JACK)  
CRN012 CORNICE CORNER TIE WIRE

**CRN090 90° Cornice Corner Covers**



CRN090 90° CORNICE CORNER COVERS

**CRN006 Cleat Screw M4 X 10**



CRN006 CLEAT SCREW M4 X 10

**CRN135 135° Cornice Corner Covers**



CRN135 135° CORNICE CORNER COVERS

**CRN007 Section Screw 4.8 X 16**



CRN007 SECTION SCREW 4.8 X 16

**CRN180 180° Cornice Corner Covers**



CRN180 180° CORNICE CORNER COVERS

**CRN008 End Plate Screw 3.5 X 13**



CRN008 END PLATE SCREW 3.5 X 13

**LANC002 Cornice Lower Infill**



LANC002 CORNICE LOWER INFILL

**LANCF001** 4.2 x 19 Pozi Pan Head Screw

---

LANCF001 4.2 X 19 S/DRILL POZI PAN HEAD SCREW A2ST



**LANCS003** Lean-To/Gable End Plate (2 Tier)

---

LANCS003 LEAN-TO/GABLE END PLATE (2 TIER)



**LANCL001** Cornice Inline Extention 3 Tier

---

LANCL001 CORNICE INLINE EXTENTION 3 TIER



**LANCS014** Cornice Inline O/L Cover 2 Tier

---

LANCS014 CORNICE INLINE O/L COVER 2 TIER



**LANCL003** Flat Cornice Endplate 3 Tier

---

LANCL003 FLAT CORNICE ENDPLATE 3 TIER



**LANCS090** Cornice Corner Extension 2 Teir

---

LANCS090 CORNICE CORNER EXTENSION 2 TEIR



**LANCL014** Cornice Inline O/L Cover 3 Tier

---

LANCL014 CORNICE INLINE O/L COVER 3 TIER

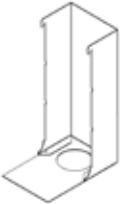

**LPCC001** Prestige Cornice Inline Jointer

---

LPCC001 PRESTIGE CORNICE INLINE JOINTER



**LANCL090** Cornice Corner Extension 3 Tier

---

LANCL090 CORNICE CORNER EXTENSION 3 TIER



**LPCD - - -** Cornice Sealing Dam

---

LPCD001 CORNICE SEALING DAM (JOINT/ENT)  
LPCD090 CORNICE SEALING DAM (MITRED JOINT)



**LANCS001** Cornice Inline Extension 2 Tier

---

LANCS001 CORNICE INLINE EXTENSION 2 TIER



**LPCG015** Cornice Eaves Sealing Foam

---

LPCG015 CORNICE EAVES SEALING FOAM

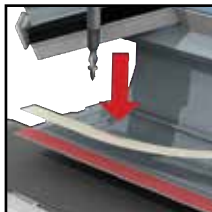

**LPCL090 Prestige Cornice Corner 90° Large Column**



LPCL090 PRESTIGE CORNICE CORNER 90° LARGE COLUMN

**SCN - - - Lower Cornice Section**



SCN Lower Cornice Section (USED WITH SUPER DUTY EAVES BEAM)

**LPCP001 Lean-To/Gable End Plate (1 Tier)**



LPCP001 LEAN-TO/GABLE END PLATE (1 TIER)

**LPCP002 Cornice Inline O/L Cover 1 Tier**



LPCP002 CORNICE INLINE O/L COVER 1 TIER

**LPCS090 Prestige Cornice Corner 90° Small Column**



LPCS090 PRESTIGE CORNICE CORNER 90° SMALL COLUMN

**LPR021 Cornice Corner 90° Large Column**



LPR021 CORNICE CORNER 90° LARGE COLUMN

**LPR022 Cornice Corner 90° Small Column**



LPR022 CORNICE CORNER 90° SMALL COLUMN



# SECTION 2 - Ridge

The ridge takes the initial structural loads and is the lynch pin of the roof system

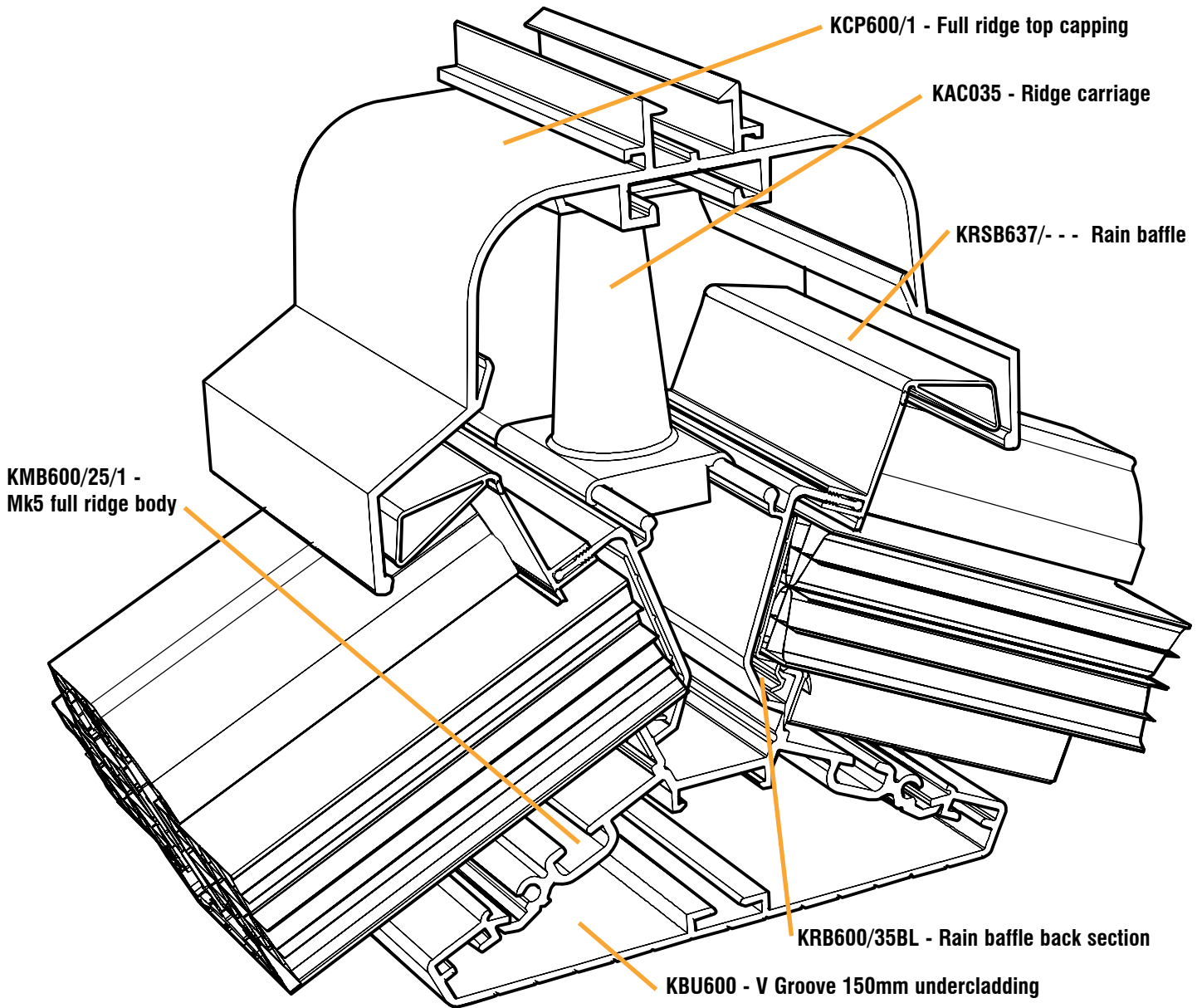

**ACC 001**      **Aluminium Cresting Finial Adaptor**

---

ACC001      FINIAL ADAPTOR



**ACC 002**      **Aluminium Finial Adaptor Fixing**

---

ACC002      FINIAL ADAPTOR FIXING



**ACC 050**      **Aluminium Cresting**

---

ACC050      ALUMNIUM CRESTINGS

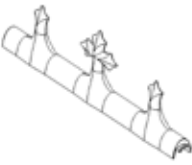

**ACF 001**      **Ball Finial - Aluminium**

---

ACF001      BALL FINIAL



**ACP ---/1**      **Aluminium Ridge Cap**

---

ACP---/1      RIDGE TOP CAP



**ACP 001**      **Aluminium Ridge Cap**

---

ACP001      EXTERNAL RADIUS END COVER



**ACP 002**      **BRUSH- EXT RADIUS END**

---

ACP002      BRUSH- EXT RADIUS END



**ACP 003**      **RADIUS END CLAMP WASHER**

---

ACP003      RADIUS END CLAMP WASHER



**ACP 004**      **RADIUS END FLASHING TRIM**

---

ACP004      RADIUS END FLASHING TRIM



**AHC ---/1**      **Aluminium Half Ridge**

---

AHC---/1      HALF RIDGE TOP CAP



**AHC - - -**      **Aluminium Half Ridge**

---

AHC001L      HALF RIDGE RADIUS END COVER-LEFT  
 AHC001R      HALF RIDGE RADIUS END COVER-RIGHT

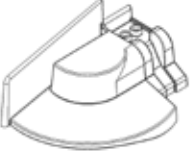

**AHC 002**      **Half Ridge Radius End Cover**

---

AHC002      BRUSH - HALF RIDGE RADIUS END COVER



**ANFC - - - Ball Finial**



ANFC002 WOK BALL  
ANFC004 PVC BALL

**CPP 050 Elizabethan Cresting**

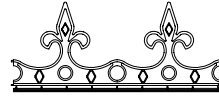

CPP050 ELIZABETHAN CREST 500MM

**ALC---/1 Lean-to Cloaking Trim**



ALC---/1 LEAN-TO CLOAKING TRIM

**CRC 090 External (270 deg) Radius End Cover**

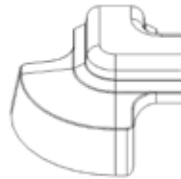

CRC090 EXTERNAL (270 DEG) RADIUS END COVER L-SHAPE HALF RIDGE

**ALP - - - Low Profile Cresting - Aluminium**



ALP---/1 LOW PROFILE CRESTING

**CRE 050 Classic Cresting**

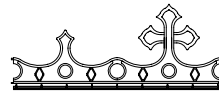

CRE050 CLASSIC CREST 500MM

**BFNA 004 Sceptre Finial**



BFNA004 SCEPTRE MOULDED FINAL

**CRU 090 Internal (270 deg) Radius End Cover**



CRU090 INTERNAL (270 DEG) RADIUS END COVER L-SHAPE HALF RIDGE

**CCE 050 Renaissance Cresting**



CCE050 RENAISSANCE CRESTING 500MM (EASY CLEAN, CLIP OVER)  
CCE100/1 RENAISSANCE ADAPTOR (ABUTS FINIAL)

**CSL 050 Tudor Cresting**



CSL050 TUDOR CREST 500MM

**CNL 050 Baroque Cresting**



CNL050 BAROQUE CREST 500MM

**CUD - - - Low profile Cresting**

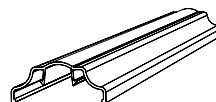

CUD600 LOW PROFILE CRESTING 6M



**DPA - - - Differential Pitch- Ridge Adaptor**

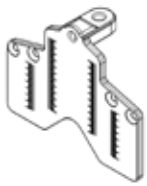

DPA001 DIFFERENTIAL PITCH- RIDGE ADAPTOR  
 DPA002 DIFFERENTIAL PITCH- RIDGE SPACER BUSH

**QGBC - - - Wallplate Internal Cladding**

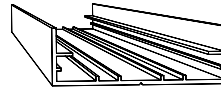

QGBC600W INT CLADDING 6M (PWLA)

**FIN - - - Classic Finial**



FIN004 CLASSIC FINIAL  
 FIN001L CLASSIC FINIAL (TO SUIT WOK)

**HCG - - - Half Wok External Capping - Georgian**



HCG003 15-20° GEORGIAN HALF WOK CAP INC CLIPS  
 HCG004 25-30° GEORGIAN HALF WOK CAP INC CLIPS  
 VBLA080/1 RAD END BRUSH 7 SERIES BAR 800MM GEORGIAN

**FLY - - - Flymesh Strip**

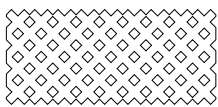

FLY620-24 FLYMESH STRIP - FULL RIDGE 24MM 6.2M  
 See UWC600/1 FOR HALF RIDGE FLYMESH

**HCV - - - Half Wok External Capping - Victorian**



HCV003 15-20° VICTORIAN HALF WOK CAP INC CLIPS  
 HCV004 25-30° VICTORIAN HALF WOK CAP INC CLIPS  
 VBLA069/1 RAD END BRUSH 7 SERIES BAR 690MM VICTORIAN

**FUDA 001 Low Profile Finial**

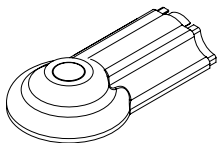

FUDA001 LOW PROFILE FINIAL

**HRP 001 Half Ridge Plate**



HRP001 HALF RIDGE ADAPTOR SMALL

**FWE 001 Full Wok External Capping**

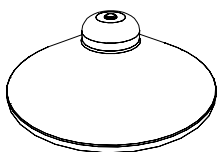

FWE001/1 FULL WOK EXTERNAL CAPPING  
 (VBC143 BRUSH CLIP 1430MM LG WHITE)  
 (VBLA143/1 RAD END BRUSH 7 SERIES 1430MM)  
 (ALSO NEED TFR200)  
 (SPECIAL CIRCUMSTANCES - NOT STANDARD)

**HRP 002 Ridge Radius End Support Bracket**

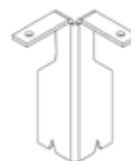

HRP002 RIDGE RADIUS END SUPPORT BRACKET - MAIN PLATE

**FWIA 001 Full Wok Internal Capping**

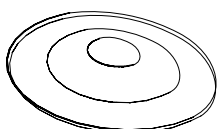

FWIA001 FULL WOK INTERNAL CAPPING  
 (ALSO NEED TFR200)  
 (SPECIAL CIRCUMSTANCES - NOT STANDARD)

**KAC 035 Ridge Carriage**

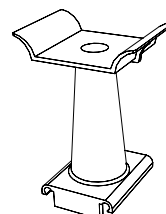

KAC035 RIDGE CARRIAGE

**KBC 075**

**Ridge Cross Brace**

KBC075 CROSS BRACE 20 DEG 75MM  
KBC075-15 CROSS BRACE 15 DEG 75MM

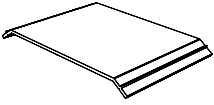

**KBC 300**

**Ridge Joint Plate**

KBC300 JOINT PLATE 300MM 20-35 DEG  
KBC300-15 JOINT PLATE 300MM 15 DEG

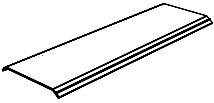

**KBEA 001**

**Radius End Undercladding Ext. Bracket**

KBEA001 UNDERCLADDING EXTENSION BRKT



**KBF 001**

**Radius End Undercladding Bracket**

KBF001 UNDERCLADDING BRACKET  
(INC IN KFKA001 KIT)



**KBS 001**

**Cross Brace Fixing Screw**

KBS001 CROSS BRACE SCREW 10 X 3/8  
(4.8 X 9.5 SELF DRILLING SCREW)

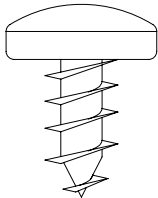

(ALSO USED TO SECURE STRUCTURAL TOP CARRIAGE - FULL OR HALF RIDGE)

**KBU - - -**

**V groove 150mm Undercladding**

KBU600 UNDERCLADDING 5.97MM WHI

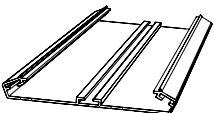

**KCG - - -**

**Georgian separate End Capping External**

KCG003 15-20DEG GEORG END CAPPING INC CLIPS  
KCG004 25-30DEG GEORG END CAPPING INC CLIPS

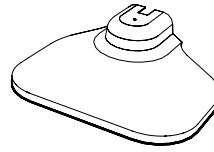

(ALSO NEED)  
VBLA080/1 RAD END BRUSH 7 SERIES BAR  
800MM GEORGIAN  
SCRA004 STARLOC WASHER

**KCP - - -**

**External Ridge Capping**

KCP600/1 EXT RIDGE CAPPING SECTION 5.98M

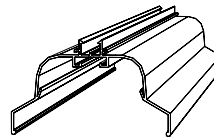

**KCS - - -**

**Ridge Top Carriage**

KCS060 RIDGE TOP CARRIAGE 60MM (10)  
KCS300 RIDGE TOP CARRIAGE 300MM

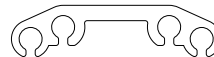

**KCT 001/1**

**Ridge Top Cap Inline Jointer**

KCT001/1 RIDGE TOP CAP INLINE JOINTER

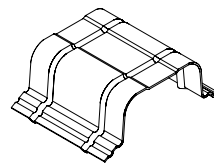

(RIVETS VSR001 & TAPE BST500A NOT INCLUDED)  
\*TRIMMED TO SUIT HALF RIDGE INLINE JOINTING

**KCV - - -**

**Victorian separate End Capping External**

KCV003 15-20 DEG VICTORIAN END CAP INC CLIPS  
KCV004 25-30 DEG VICTORIAN END CAP INC CLIPS

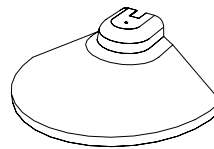

(ALSO NEED)  
VBLA069/1 RAD END BRUSH 7 SERIES BAR  
690MM VICTORIAN  
SCRA004 STARLOC WASHER

**KDS 001**

**Die Cast End/Ridge Bolster Fixing Screws**

KDS001 FULL RIDGE DIE CAST END & TBRK  
RIDGE BOLSTER FIXING SCREWS  
(4.8 X 25 SELF TAPPING SCREW)



**KDS 002** **Half Ridge Die Cast End Upper Screw**

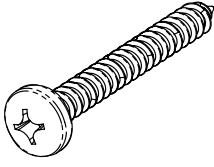

KDS002 HALF RIDGE DIE CAST END UPPER SCREW  
(4.8 X 38 SELF TAPPING SCREW)

**KDS 003** **Half Ridge Adaptor Plate Lower Screws**

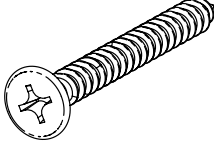

KDS003 HALF RIDGE ADAPTOR PLATE LOWER SCREWS  
(5 X 37 C/SINK WOOD SCREW)

**KFD 001** **Georgian Cap Finial Disk**



KFD001 GEORGIAN CAP FINIAL DISK  
(USED WITH KGEA001)

**KFKA 001** **Internal Radius End Fixing Kit**

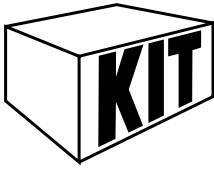

KFKA001/1 RADIUS END FIXING KIT WHITE

**KIT CONTENTS**  
 KBF001 RAD END UNDERCLADDING BRACKET  
 KLB001 ROSELOCK FIXING BUTTON  
 SCRA001 ROOFING BOLT AND NUT

**KFT 001** **Ridge Flashing Trim**

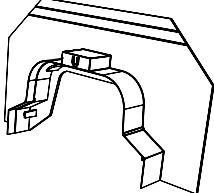

KFT001 RIDGE FLASHING TRIM

**KGEA 001** **Gable End Complete**

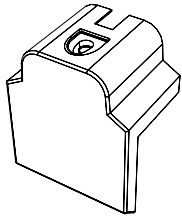

KGEA001 GABLE END CAP COMPLETE  
(INCLUDES KFD001 FINIAL DISC)

**KGR - - -** **Georgian Internal Separate End Cover**

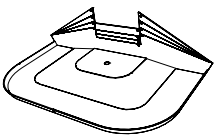

KGR001 GEORGIAN SEP END COVER SMALL  
 KGR002 GEORGIAN SEP END COVER LARGE

**KHB - - -** **Half Ridge/Lantern Baffle Support Wing**

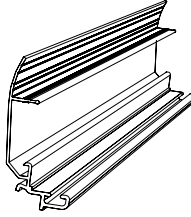

KHB600/35 HALF RIDGE ALUM BAFFLE SUPPORT WING 6M

**KHC - - -** **Half Ridge Top Capping**

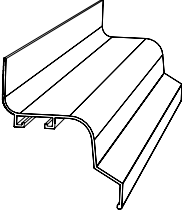

KHC600 HALF RIDGE TOP CAPPING 6M

**KHF 001** **Ridge/Half Ridge Capping Jointer**

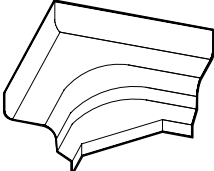

KHF001 RIDGE/HALF RIDGE CAPPING JOINTER  
(TOP OF VALLEY)

**KHG - - -** **Georgian Half Ridge Radius End Cap**

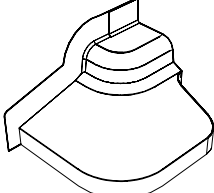

KHG015L-21 15DEG GEORGIAN 21TRIM LEFT  
 KHG015R-21 15DEG GEORGIAN 21TRIM RHT  
 KHG025L-21 25DEG GEORGIAN 21TRIM LEFT  
 KHG025R-21 25DEG GEORGIAN 21TRIM RHT

(ALSO NEED)  
 VBC044 BRUSH CLIP 440MM  
 VBLA044/1 RAND END BRUSH 440MM

**KHI - - -** **Victorian Half Ridge & Wok Under Capping**

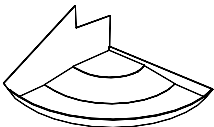

KHI001L HR UNDER CAP SM RADIUS LEFT  
 KHI001R HR UNDER CAP SM RADIUS RIGHT  
 KHI002L HR UNDER CAP LRG RADIUS LEFT  
 KHI002R HR UNDER CAP LRG RADIUS RIGHT

**KHI - - -**

**Georgian Half Ridge & Wok Under Capping**

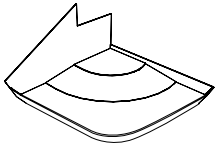

KHI003L HR UNDER CAP SM RADIUS LEFT  
 KHI003R HR UNDER CAP SM RADIUS RIGHT  
 KHI004L HR UNDER CAP LRG RADIUS LEFT  
 KHI004R HR UNDER CAP LRG RADIUS RIGHT

**KHV - - -**

**Victorian Half Ridge Radius End Cap**

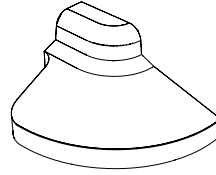

KHV015L-21 15DEG VICTORIAN 21TRIM LFT  
 KHV015R-21 15DEG VICTORIAN 21TRIM RHT  
 KHV025L-21 25DEG VICTORIAN 21TRIM LFT  
 KHV025R-21 25DEG VICTORIAN 21TRIM RHT

(ALSO NEED)  
 VBC380 BRUSH CLIP 380MM VBLA038/1 RAD  
 END BRUSH 380MM

**KHL 001**

**Half Ridge End Cap (Left)**

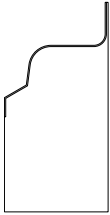

KHL001 HALF RIDGE END CAP (LEFT)

(KHR FOR RIGHT HAND)

**KJB - - -**

**Ridge Joint Bracket Kit (300mm)**

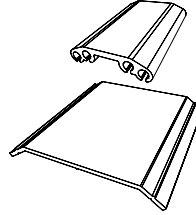

KJB001 JOINT BRACKET KIT 15 DEG  
 KJB002 JOINT BRACKET KIT 20-35D

(INCLUDES 24 X RCS001 FIXING SCREWS)

**KHM - - -**

**Mk5 Half Ridge Main Body**

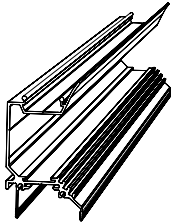

KHM600 HALF RIDGE MAIN BODY 6M

**KLB 001**

**Rose Locking Fixing Button**

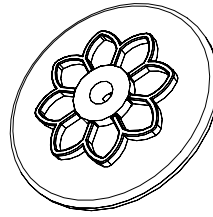

KLB001 ROSE LOCKING FIXING BUTTON

(INC IN KFKA001 KIT)

**KHR 001**

**Half Ridge End Cap (Right)**

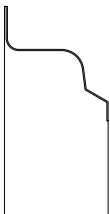

KHR001 HALF RIDGE END CAP (RIGHT)

(KHL FOR LEFT HAND)

**KMBA - - -**

**Mk5 Full Ridge Main Body (Punched & Meshed)**

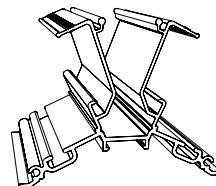

KMBA600/35/15/1 MK5 FULL RIDGE BODY - 15°  
 KMBA600/35/20/1 MK5 FULL RIDGE BODY - 20°  
 KMBA600/35/25/1 MK5 FULL RIDGE BODY - 25°  
 KMBA600/35/30/1 MK5 FULL RIDGE BODY - 30°  
 KMBA600/35/35/1 MK5 FULL RIDGE BODY - 35°  
 KMBA600/35/40/1 MK5 FULL RIDGE BODY - 40°

**KHS 060**

**Half Ridge Structural Carriage**

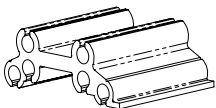

KHS060 HALF RIDGE STRUCTURAL CARRIAGE

**KOB 002**

**Ventilation Button**



KOB002 VENTILATION OPERATION BUTTON

(MAIN RIDGE UNDERCLADDING)

**KHU - - -**

**Half Ridge/Lantern Under Cladding**

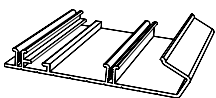

KHU600 UNDERCLADDING 6M WH

**KRB - - -**

**Rain Baffle Back Section**

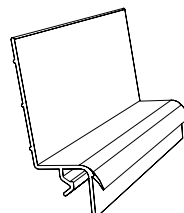

KRB600/35BL RAIN BAFFLE BACK SECTION  
 35MM BLACK 6M

**KRSB - - - Rain Baffle**

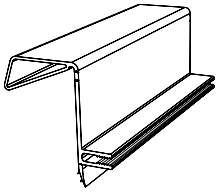

KRSB637/16L 7 SE'S 25MM LOW PITCH 6.3m  
 KRSB637/16S 7 SE'S 25MM STEEP PITCH 6.3m  
 KRSB637/32L 7 SE'S 35MM LOW PITCH 6.3m  
 KRSB637/32S 7 SE'S 35MM STEEP PITCH 6.3m

**RCS - - - Ridge Structural Carriage Screws**

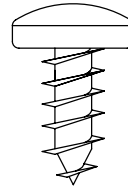

RCS001 RIDGE CARRIAGE SCREWS  
 4.2 X 13MM  
 RCS002 HALF RIDGE WING TO MAIN BODY  
 4.2 X 10MM

**KTBA 001 Ridge T Bolt and Fixing Wedge**

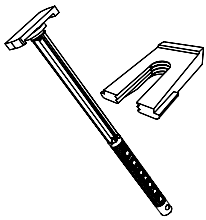

KTBA001/1 RIDGE T BOLT  
 KTBA001/2 FIXING WEDGE

(IN CONJUNCTION WITH KAC 035 )

**RHK 001 Ridge Hanger Kit (TBRK)**

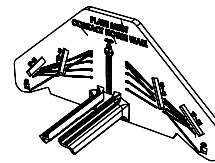

RHK001 RIDGE HANGER KIT

**KIT CONTENTS**

SRCP001 COMPRESSION PLATE (1)  
 SSB030 STARTER REINFORCEMENT (2)  
 RHSK001 HANGER SUB KIT  
 SRE003 TBRK LABEL  
 CIL178 CONTENTS LIST

**KVRA - - - Radius End Undercladding**

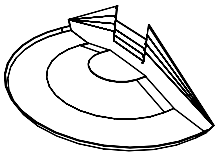

KVRA001 SMALL RADIUS END UNDERCLADDING  
 KVRA002 LARGE RADIUS END UNDERCLADDING

**SARC - - - Ridge Bolster (TBRK)**

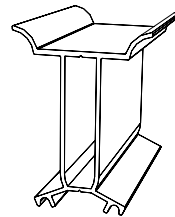

SARC600 RIDGE BOLSTER

**PSF 004 Pikestaff Finial**

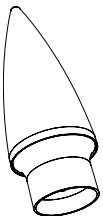

PSF004 PIKESTAFF FINIAL

**SBB 001 Starter Bar Fixing Bracket**



SBB001 STARTER BAR FIXING BRACKET



**PWLA - - - Lean-to Wallplate Body**



PWLA600/1 LEAN TO WALL PLATE BODY  
 5-45 DEG WALL PLATE 6M

(NO TOP CAPPING SUPPLIED)

**SFNA 004 Coronet Finial**



SFNA004 CORONET FINIAL

**RAP - - - Ridge Adaptor**



RAP001 CAST RIDGE ADAPTOR 25-30 DEG  
 RAP002 CAST RIDGE ADAPTOR 15-20, 35 DEG  
 RAP003 CAST RIDGE ADAPTOR 40 DEG

**SFS 001 Speedlok 2 Fixing Screw**



SFS001 SPEEDLOK 2 FIXING SCREW

**SHI - - -**

**Internal Radius End Covers**



- SHI001L Vic Small Int Rad End Cover H/R
- SHI001R Vic Small Int Rad End Cover H/R
- SHI002L Vic Large Int Rad End Cover H/R
- SHI002R Vic Large Int Rad End Cover H/R
- SHI003L Geor Small Int Rad End Cover H/R
- SHI003R Geor Small Int Rad End Cover H/R
- SHI004L Geor Large Int Rad End Cover H/R
- SHI004R Geor Large Int Rad End Cover H/R
- SHI010/1 Rose Fixing Plate Assembly
- SHI010/2 Nylon Washer Nut

**SLH - - -**

**Die Cast Ridge Weathering Shield**



- SLH002 HUB WEATHERING SHIELD
- SLH006 FULL WOK WEATHERING SHIELD
- SLH007 QUARTER WOK WEATHERING SHIELD
- SLH008 3/4 'L' WEATHERING SHIELD
- SLH013 3/4 WOK WEATHERING SHIELD
- SLH014 1/2 WOK WEATHERING SHIELD

**SLH - - -**

**Die Cast Ridge End**



- SLH004 SPEEDLOK HUB 1/4 ADAPTOR
- SLH005 TIE BAR/ BRACKET FOR INT RAD FIX
- SLH009 FULL WOK DIE CAST END
- SLH010 3/4 WOK DIE CAST END
- SLH011 1/2 WOK DIE CAST END
- SLH012 1/4 WOK DIE CAST END
- SLH015 1/2 RIDGE L SHAPE HUB SUPPORT BRACKET

**SLHA - - -**

**New Die Cast End - Half Ridge**



- SLHA001 SPEEDLOK HUB
- SLHA001L SPEEDLOK HALF RIDGE HUB
- SLHA001R SPEEDLOK HALF RIDGE HUB
- SLHA003 SPEEDLOK EXT CORNER DIE CAST

(THE ABOVE USED FOR HALF RIDGES- CUT TO SUIT)

**SSA 001**

**Speedlok 2 Socket Assembly**



- SSA001 SPEEDLOCK 2 SOCKET ASSEMBLY

**SSC 001**

**Speedlok Housing Spacer**



- SSC001 SPEEDLOK HOUSING SPACER

**TFR 200**

**Threaded Fixing Rose**



- TFR200 THREADED FIXING ROSE (INT RAD END TO LOW PRO CREST)
- ALSO USED ON FULL WOK

**TWR 001**

**Wok Threaded Fixing Rose**

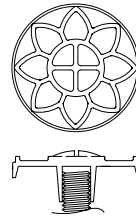

- TWR001 WOK THREADED FIXING ROSE 100MM
- TWR001L WOK THREADED FIXING ROSE 150MM

**UOB 001**

**Opening Button**

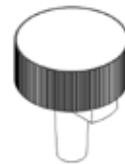

- UOB001 OPENING BUTTON ON UNDERCLADDING
- (HALF RIDGE OR VENTILATED WALLPLATE)

**UWC - - -**

**Half Ridge Flymesh**



- UWC600/1 FLYMESH STRIP (18MM) - HALF RIDGE

**VSR 001**

**Plastic Snap Rivet - Ridge Cap**

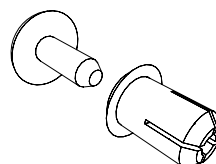

- VSR001 PLASTIC SNAP RIVETS-RIDGE CAP

**WCP 001**      **Ventilated Wallplate 5 Degree Packer**

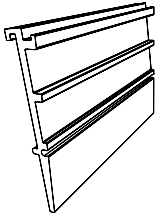

WCP001/1    WALLPLATE 5° PACKER  
(PITCHES FROM 15 TO 30 DEGS)

**WCS - - -**      **Ventilated Wallplate Carriage**

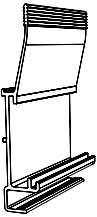

WCS100/35    WALLPLATE CARRIAGE 100MM

**WEC 001**      **Ventilated Wallplate End Cap**

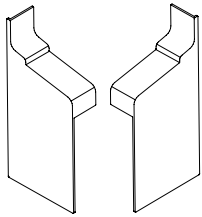

WEC001/L    WALLPLATE END CAP (LEFT)  
WEC001/R    WALLPLATE END CAP (RIGHT)

**WMB - - -**      **Ventilated Wallplate Main Body**

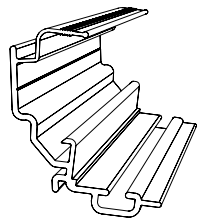

WMB60035/1    WALLPLATE MAIN BODY (5-10°)  
WMB60035/2    WALLPLATE MAIN BODY (10-15°)

**WTC - - -**      **Ventilated Wallplate Top Capping**

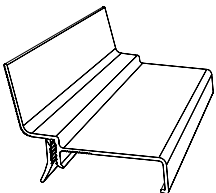

WTC600/1    WALLPLATE TOP CAPPING

**WUC - - -**      **Ventilated Wallplate Undercladding**

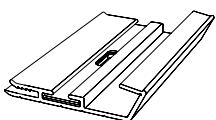

WUC600        INCLUDING MESH OR BUTTON  
WUC600/1      WALLPLATE UNDERCLADDING  
INCLUDING VENT STRIP

# SECTION 3 - Glazing bars

Glazing bars are the members that retain the glazing material and take structural loads down to the eaves

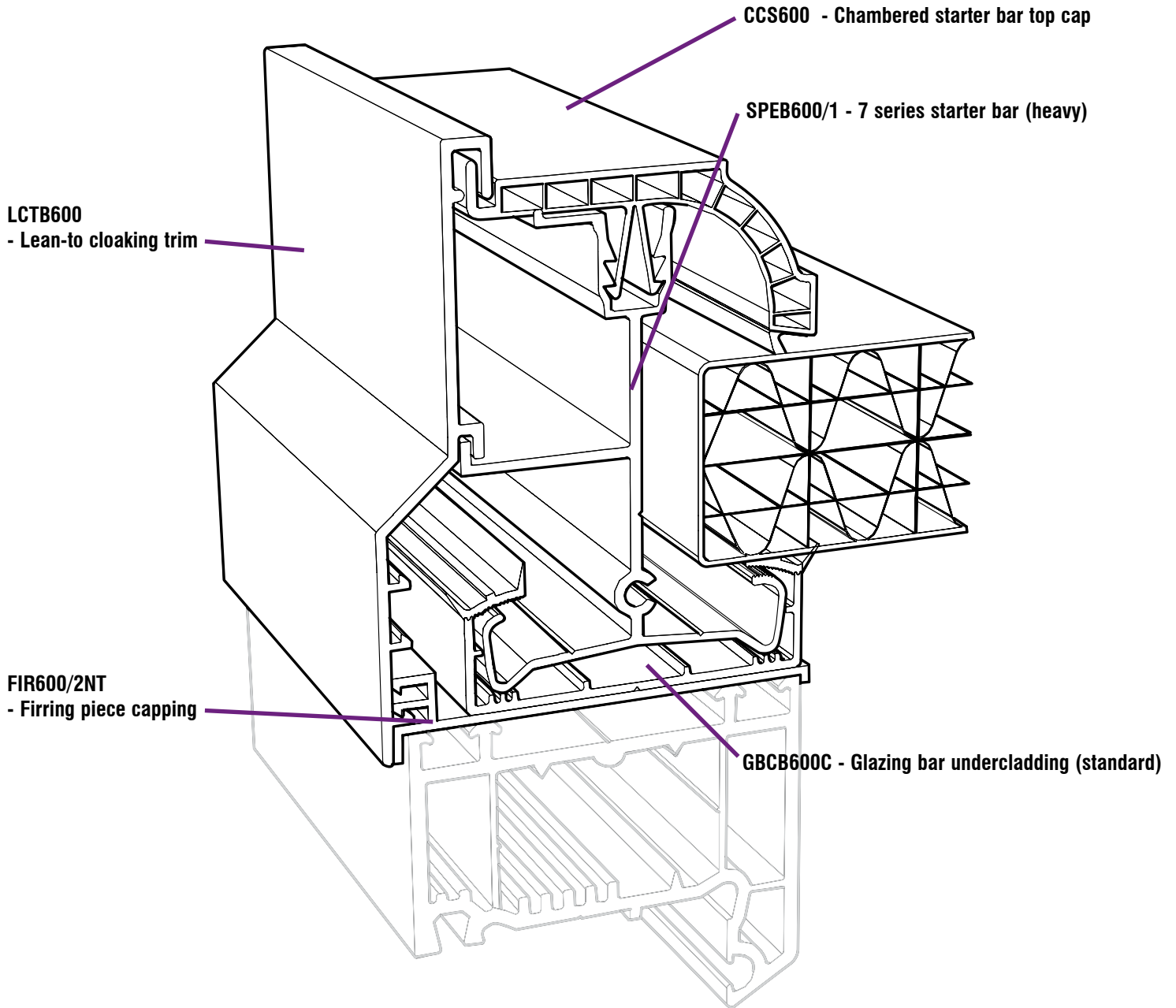



**AGC- - -** Georgian Top Cap - Aluminium

---

AGC---/25 GEORGIAN TOP CAP



**AGS- - -** Qlon Gasket

---

AGS250 QLON GASKET  
AGS350 QLON GASKET

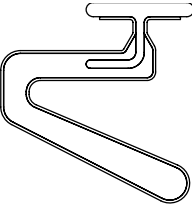

**ALC- - -** Lean to Cloaking Trim - Aluminium

---

ALC---/1 LEAN TO CLOAKING TRIM



**ASC- - -** Starter Bar Top Cap - Aluminium

---

ASC---/25 STARTER BAR TOP CAP



**ATC- - -** Transom Top Cap - Aluminium

---

ATC---/25 TRANSOM TOP BAR



**BEC 001** Bolster Bar End Cap

---

BEC001 BOLSTER BAR END CAP

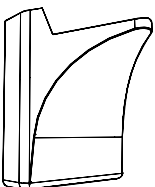

**BFK 020** Bolster Bar Fixing Kit

---

BFK020 BOLSTER BAR FIXING KIT PACK INCLUDING SELF SEALING WASHER (6.3 X 25)  
  
(PACK OF 20)

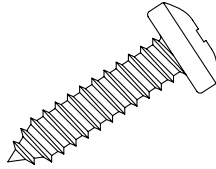

**BFS 001** Bolster Fixing Screw

---

BFS001 BOLSTER BAR FIXING SCREW

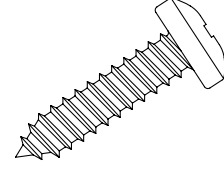

**CAPA - - -** Glazing Bar Top Cap

---

CAPA6011 GLAZING BAR TOP CAP STARTER  
CAPA604 GLAZING BAR TOP CAP VIC/TRANSOM  
CAPA606 GLAZING BAR TOP CAP GEORGIAN  
  
(24/25MM GLAZING ONLY)

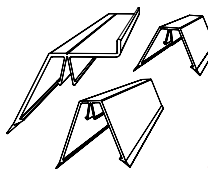

**REMEDIALS ONLY**

**CCA - - -** Chambered Glazing Bar Top Cap (Dome)

---

CCA600\_/25 TRANSOM CAPPING 25MM  
CCA600\_/35 TRANSOM CAPPING 35MM

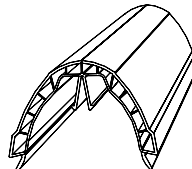

**CCE 001** Chambered Starter Bar End Cap

---

CCE001L\_ - CHAMBERED STARTER BAR END CAP (LEFT)  
CCE001R\_ - CHAMBERED STARTER BAR END CAP (RIGHT)

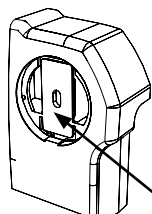

'Snap out' bar end cap fixing blocks

**CCE 002** Chambered End Cap (Gable/Lean-to)

---

CCE002L\_ - CHAMBERED END CAP GABLE/LEANTO (LEFT)  
CCE002R\_ - CHAMBERED END CAP GABLE/LEANTO (RIGHT)

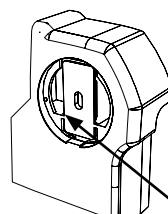

'Snap out' bar end cap fixing blocks

**SECTION 3** - Glazing bars

**CCG - - -**

**Chambered Georgian Glazing Bar Top Cap**

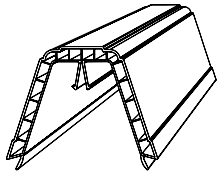

CCG600\_/25 GEORGIAN CAPPING 25MM  
CCG600\_/35 GEORGIAN CAPPING 35MM

\*USE WITH DOME OR BEVEL DESIGN

**DCM 001/WV**

**Decorative End Cap Circle**



DCM001/WV DECORATIVE END CAP  
CONCENTRIC CIRCLE

(ONE NEEDED WITH EACH END CAP)

**CCG 001**

**Chambered Georgian Glazing Bar End Cap**



CCG001\_ CHAMBERED GEORGIAN END CAP

**DGCE 010**

**Glass Clip Pack**



DGCE010 GLASS CLIP PACK (5 LEFT, 5 RIGHT)

**CCS - - -**

**Chambered Starter Bar Top Cap**

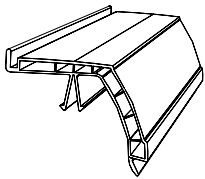

CCS600\_/25 - CHAMBERED STARTER BAR TOP CAP 25  
CCS600\_/35 - CHAMBERED STARTER BAR TOP CAP 35

\*USE WITH DOME OR BEVEL DESIGN.

**DSBC600C**

**Glazing Bar Cladding**



DSBC600C GLAZING BAR CLADDING

**CCT - - -**

**Chambered Glazing Bar Top Cap (Bevel)**

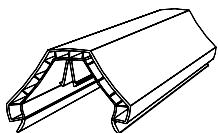

CCT600\_/25 TRANSOM CAPPING 25MM  
CCT600\_/35 TRANSOM CAPPING 35MM

**EFSA 021**

**Endcap Fixing Screw**

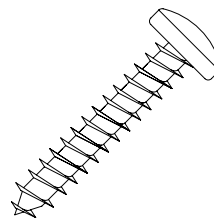

EFSA021 STANDARD (20 PACK)  
(4.8 X 25 SELF TAPPING SCREW)

**CCTA 001**

**Chambered Glazing Bar End Cap (Dome)**

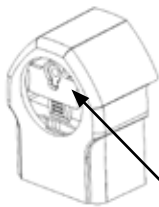

CCTA001 DOME CHAMBERED TRANSOM END CAP

Snap out\* bar end cap fixing blocks

**FIR - - -**

**Firring Piece Capping (Use with LTCB---)**

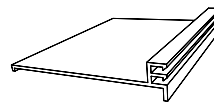

FIR600/2NT FIRRING PIECE CAPPING 6M NO TAPE

(SEE ALSO LCTB)

**DCM 001**

**Decorative End Cap Rose Motif**

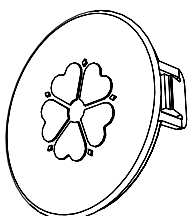

DCM001 DECORATIVE END CAP ROSE MOTIF  
(ONE NEEDED WITH EACH END CAP)

**GBCB - - -**

**Glazing Bar Undercladding (Standard)**

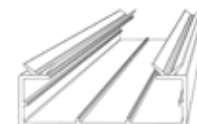

GBCB600C GLAZING BAR CLADDING 6M WHITE

**GCRA 002** Glazing Bar Top Cap Removal Tool

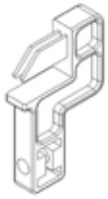

GCRA002 GLAZING BAR TOP CAP REMOVAL TOOL

**LSL 001** Long Speedlock 2 Assembly



LSL001 LONG SPEEDLOCK 2 ASSEMBLY

**IRK - - -** Inter Rafter Kit

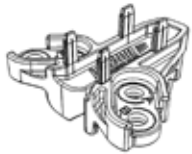

IRK001 INTER RAFTER TENNON  
 IRK002 STRUCTURAL JACK RAFTER BASE KIT  
 IRK003 INTER RAFTER WEATHERING SHIELD  
 IRK005 FLASHING TRIM- RUNNER

**LVCC 001** Aluminum Top Capping Fixing Cap



LVCC001 ALUMINIUM TOP CAPPING FIXING CLIP

**JRKA - - -** Jack Rafter Kit

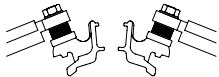

JRKA001/2 JACK RAFTER CHANNEL INFIL 15MM  
 JRKA002 JACK RAFTER KIT(7)  
 JRKA003 JACK RAFTER KIT 7+ REINF BAR  
 JRKA004/1 M4 X 12 PZ PAN  
 JRKA004/3 M6 FM B PLAIN WASHER

**LWH 001** Long Speedlok 2 Weathering Hood



LWH001 LONG SPEEDLOK 2 WEATHERING HOOD

**JRT 015** Jack Rafter Tenon



JRT015 JACK RAFTER TENON

**MBBA - - -** Bolster Bar - Aluminium

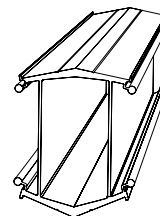

MBBA550/1 ALUMINIUM BOLSTER BAR

**JRT 027** Structural Jack Rafter Tenon

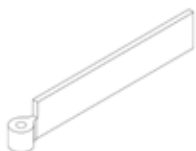

JRT027 STRUCTURAL JACK RAFTER TENON

**MBB - - -** Bolster Bar - PVC Claddings

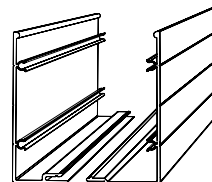

MBB550/2 BOLSTER PVC CLADDING (FEMALE)  
 MBB550/3 BOLSTER PVC CLADDING (MALE)

**LCTB - - -** Lean-to Cloaking Trim

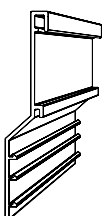

LCTB600 LEAN-TO CLOAK TRIM 6M

(SEE ALSO FIR)

**RECA 001** Glazing Bar End Cap - Transom/ Hip



RECA001 GLAZING BAR END CAP (MOTIF)

**REMEDIALS ONLY**

FIXING PLATE  
 (ALREADY ATTACHED)

Used also on Bevelled PCV Top Cap

**RECA - - - Glazing Bar End Cap - Starter**

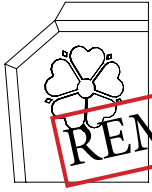

RECA001L STARTER END CAP (MOTIF) LEFT  
RECA001R STARTER END CAP (MOTIF) RIGHT

**REMEDIALS ONLY**

FIXING PLATE  
(ALREADY ATTACHED)

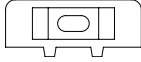

Used also on Bevelled PCV Top Cap

**SPT 600L/1 7 Series Transom/Vic Bar (Light)**

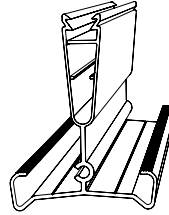

SPT600L/1 LIGHT TRANS/VIC GLAZING BAR 6M

**RECB 002 Glazing Bar End Cap  
(lean-to and gable application)**



RECB002L LEAN-TO & GABLE END CAP (MOTIF) LEFT  
RECB002R LEAN-TO & GABLE END CAP (MOTIF) RIGHT

**REMEDIALS ONLY**

FIXING PLATE  
(ALREADY ATTACHED)

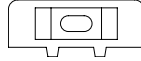

Used also on Bevelled PCV Top Cap

**SPT 600M/1 7 Series Transom/Vic Bar (Medium)**



SPT600M/1 MEDIUM TRANS/VIC GLAZING BAR  
6M

**SPE - - - 7 Series Starter Bar (Light)**

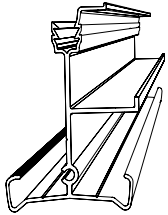

SPE600L/1 LIGHT STARTER BAR 6M

**SPTA - - - 7 Series Transom/Vic Bar (Heavy)**

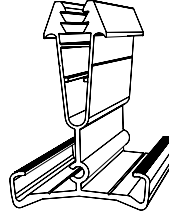

SPTA600/1 TRANSOM GLAZING BAR (78MM) 6M

**SPE - - - 7 Series Starter Bar (Medium)**



SPE600M/1 STARTER GLAZING BAR (78) 6M

**SRGB - - - Georgian Structural Reinforcement**

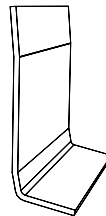

SRGB600 GEORGIAN STRUCTURAL  
REINFORCEMENT 6M

PLEASE USE TWO PIECES PER BAR

USE JRKA004/1 (SCREW) TO SECURE

**SPGA - - - 7 Series Georgian Bar (Light)**

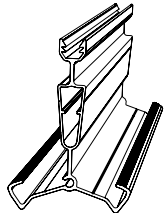

SPGA600L/1 LIGHT GEORGIAN HIP BAR 6M

**SRTB - - - Transom Structural Reinforcement**

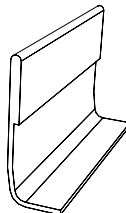

SRTB600 TRANSOM STRUCTURAL  
REINFORCEMENT 6M

PLEASE USE TWO PIECES PER BAR

USE JRKA004/1 (SCREW) TO SECURE

**SPGC - - - 7 Series Georgian Bar (Heavy)**

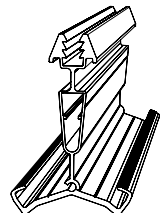

SPGC600/1 GEORG HIP GLAZING BAR (78MM) 6M

**SSL - - - Short Speedlok 2 Assembly**



SSL001 SHORT SPEEDLOK 2 ASSEMBLY

**SWH - - - Weathering Hood Short**

SWH001 WEATHERING HOOD SHORT



**TCAC - - - Anchor Clips**

TCAC500 ANCHOR CLIPS  
(PACK OF 500)



# SECTION 4 – Valley

Another structural member that links the ridge to the eaves. It enables more complex roof shapes to be designed

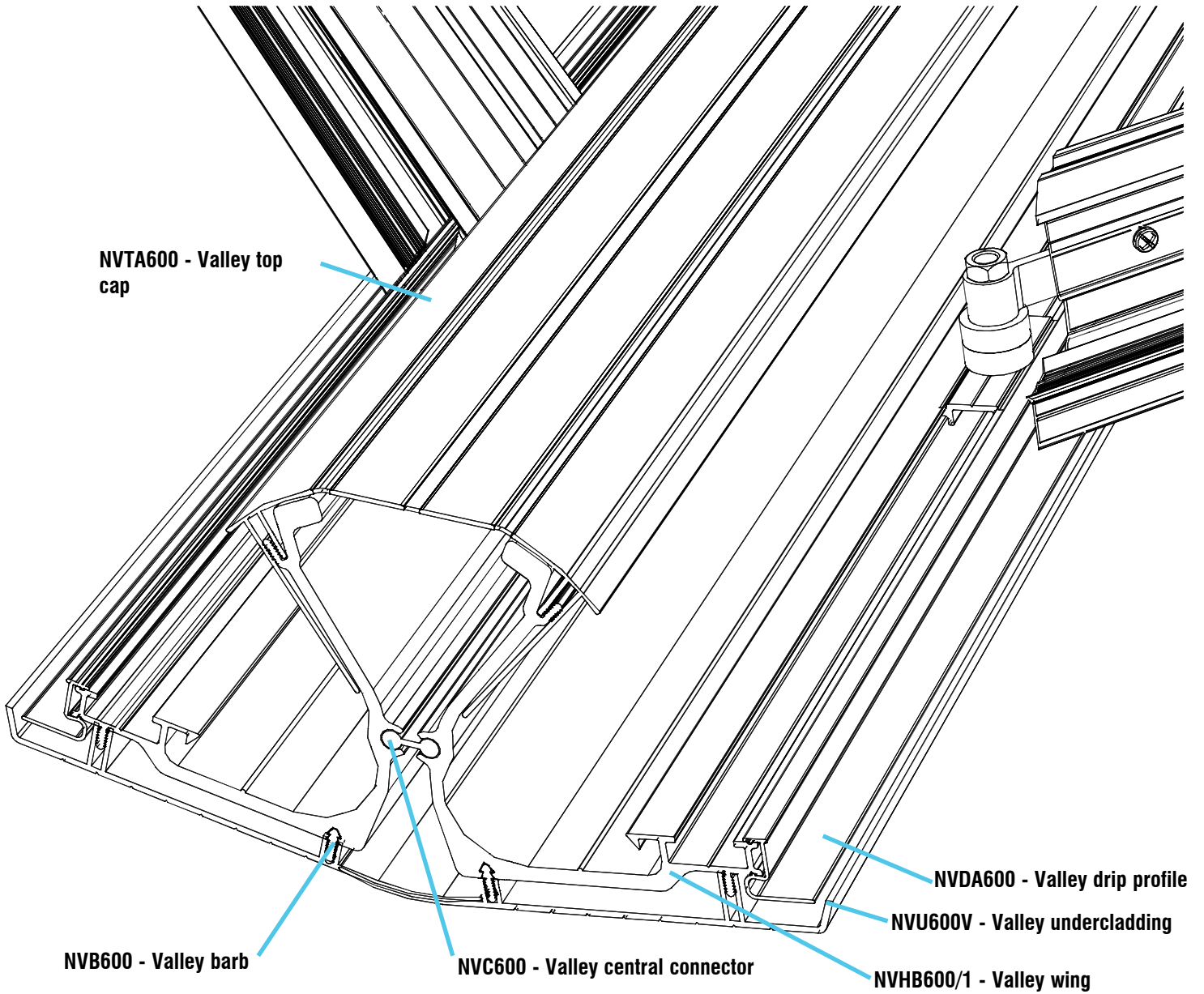

**NVB - - - Valley Barb**

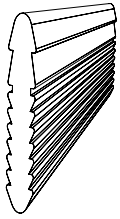

NVB600 VALLEY BARB 6M  
(TWO PER VALLEY)

**NVU - - - Valley Undercladding V Groove**

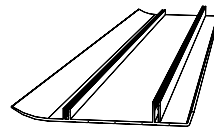

NVU600V VALLEY UNDERCLADDING 6M WHITE  
(TWO PER VALLEY)

**NVC - - - Valley Central Connector**

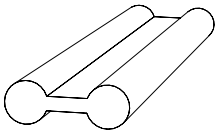

NVC600 VALLEY CENTRAL CONNECTOR 6M

**VPC010 Valley Clip**

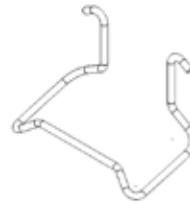

VPC010 VALLEY CLIP

**NVDA - - - Valley Drip Profile**

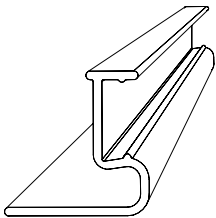

NVDA600 VALLEY DRIP PROFILE 6M

**VRK - - - Valley Rafter Kit**

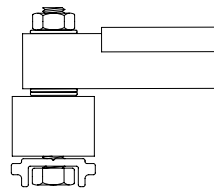

VRK002 VALLEY RAFTER KIT  
VRK003 VALLEY RAFTER KIT STRUCTURAL

**NVE 002 Valley End Cap/ Fixing Kit**

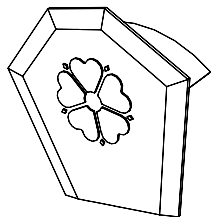

NVE002 VALLEY END CAP/FIXING KIT(4M/6M)  
(INCLUDES - VSR001 PLASTIC SNAP RIVETS)

**NVHB - - - Valley Wing**

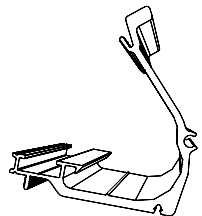

NVHB600/1 VALLEY WING 6M

**NVTA - - - Valley Top Cap**

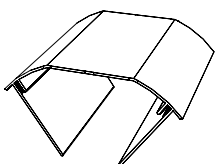

NVTA600 VALLEY TOP CAP 6M

# SECTION 5 - Guttering

Rainwater disposal is essential and in this section are structural box gutters too

For further visual help with box gutter adaptor and rain water pipe outlet identification, please turn to pages 33 & 34

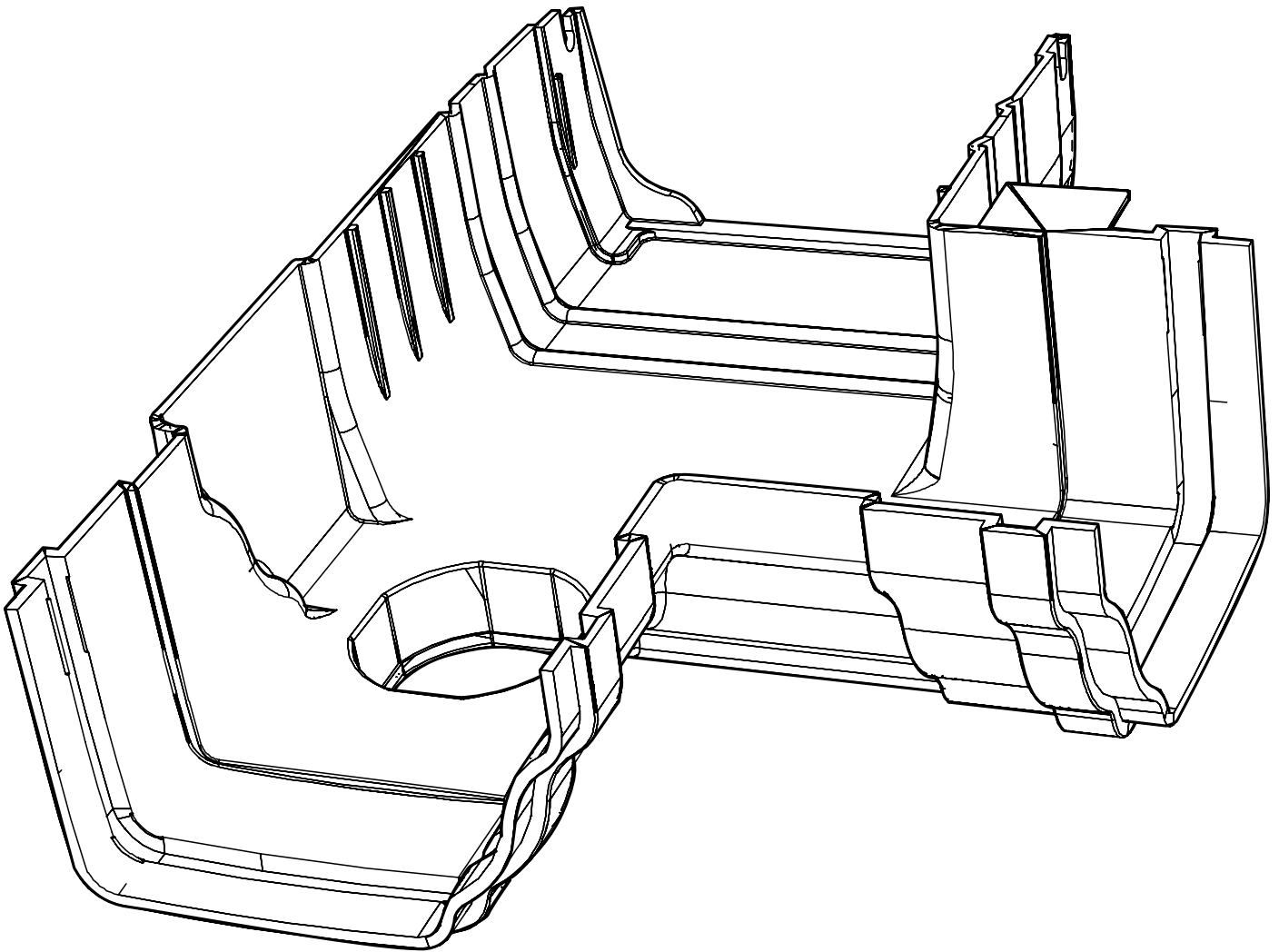



**AAHA ---/1 Bolt Slot Attached Raised Back Box Gutter**

AAHA---/1 BOLT SLOT ATTACHED TO HEAD OF RAISED BACK BOX GUTTER



**BGIA - - - Box Gutter Insulation**

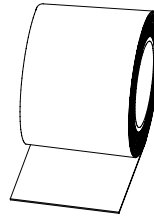

BGIA422 INSULATION 4M ROLL - 165 b.g  
 BGIA622 INSULATION 6M ROLL - 165 b.g  
 BGIA432 INSULATION 4M ROLL - 265 b.g  
 BGIA632 INSULATION 6M ROLL - 265 b.g

**BAS 075BL Box gutter 75ml Tube of Sealant**

BAS075BL BOXGUTTER 75ML TUBE OF SEALANT (Gutterbond)

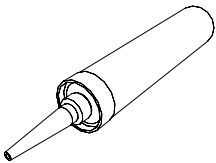

**BGRA 005 165mm Box Gutter Reinforcement (strap)**

BGRA005/S 165MM REINFORCEMENT 50MM X 5

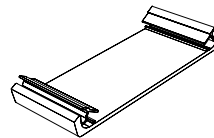

**BES 001 Bottom Elbow Shoe (RWP)**

BES001 BOTTOM ELBOW SHOE

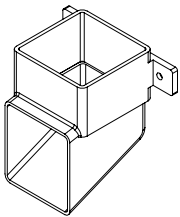

**BST - - - Box Gutter Sealing Tape**

BST001A BOX GUTTER SEALING TAPE 20M  
 BST500A BOX GUTTER SEALING TAPE 500MM



**BGAA - - - Box Gutter Adaptors (SEE p40)**

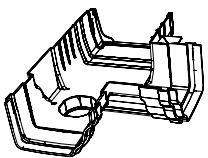

165MM ADAPTORS  
 BGAA001L/1 STRAIGHT INLINE LEFT  
 BGAA001R/1 STRAIGHT INLINE RIGHT  
 BGAA002L/1 90° LEFT  
 BGAA002R/1 90° RIGHT  
 BGAA003L/1 90° WITH OUTLET LEFT  
 BGAA003R/1 90° WITH OUTLET RIGHT  
 BGAA004L/1 135° WITH OUTLET LEFT  
 BGAA004R/1 135° WITH OUTLET RIGHT  
 BGAA005L/1 INLINE OFFSET LEFT  
 BGAA005R/1 INLINE OFFSET RIGHT  
 BGAA007L/1 90° OFFSET LEFT  
 BGAA007R/1 90° OFFSET RIGHT  
 BGAE001L 90° WITH TRUNK OUTLET LEFT  
 BGAE001R 90° WITH TRUNK OUTLET RIGHT  
 BGSE001L STOP END WITH OUTLET LEFT  
 BGSE001R STOP END WITH OUTLET RIGHT

265MM ADAPTORS  
 BGAA261L/1 ASSY C/W OUTLET  
 BGAA261R/1 ASSY C/W OUTLET  
 BGAA262L/1 ASSY C/W RETURN  
 BGAA262R/1 ASSY C/W RETURN  
 BGAA263L/1 ASSY + STOP END  
 BGAA263R/1 ASSY + STOP END  
 BGAE263L 90° OFFSET WITH TRUNK OUTLET LEFT  
 BGAE263R 90° OFFSET WITH TRUNK OUTLET RIGHT  
 BGAW001L 90° LEFT  
 BGAW001R 90° RIGHT  
 BGAW002L 90° WITH TRUNK OUTLET LEFT  
 BGAW002R 90° WITH TRUNK OUTLET RIGHT  
 BGAW003L 90° LEFT WITH OUTLET  
 BGAW003R 90° RIGHT WITH OUTLET

**DBU - - - Decorative Box Gutter Cladding**

DBU600S 165MM CLADDING 6M  
 DBUA600L 265MM CLADDING 6M

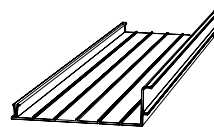

**EETA001 Trunk Outlet (Cornice)**

EETA001 TRUNK OUTLET (CORNICHE)

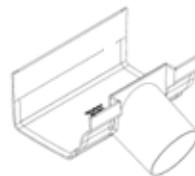

**ESA - - - Marley Classic Gutter**

ESA001L MARLEY CLASSIC GUTTER LEFT  
 ESA001R MARLEY CLASSIC GUTTER RIGHT  
 (STD 80MM OFFSET TO STEP ROUND STD BRICK)



**FBM 600**



FBM600 NEW PARABOLIC HEAD USED ON ALL IN HOUSE RAISED BACK BOX GUTTER

**GAD - - - Gutter to RWP Adaptor**

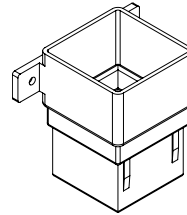

GAD001 GUTTER TO SQUARE RWP ADAPTOR  
 GAD002 GUTTER TO ROUND RWP ADAPTOR  
 (GUTTER OUTLET TO RWP AND RWP TO RWP JOINTER)

**FGB 001**

**Flowline Gutter Bracket Screw Fix**



FGB001 SCREW FIX FLOWLINE GUTTER BRACKET

**GBLA 001**

**Gallows Bracket (265mm Box Gutter)**

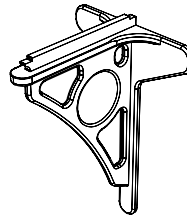

GBLA001 GALLOWS BRACKET 265 MM

**FIA 001**

**90 Deg Flowline Gutter Angle**

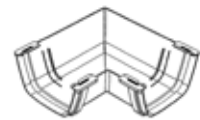

FIA001 90 DEG FLOWLINE GUTTER ANGLE

**GBSA 001**

**Gallows Bracket (165mm Box Gutter)**

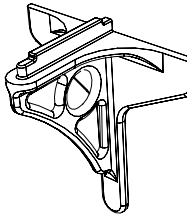

GBSA001 GALLOWS BRACKET 165MM

**FJB 001**

**Gutter Jointer Flowline**



FJB001 GUTTER JOINTER FLOWLINE

**HOP 001**

**Hopper Head**



HOP001 HOPPER HEAD

**FRO 001**

**Running Outlet Flowline**

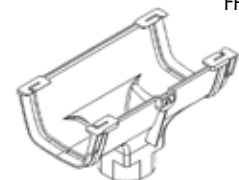

FRO001 RUNNING OUTLET FLOWLINE

**MEA 001**

**Classic Gutter External 90 Degrees**

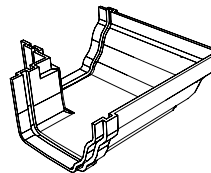

MEA001 GUTTER 4LT EXTERNAL 90 DEG

**FSE - - -**

**Stop End Outlet Flowline**



FSE001 STOP END OUTLET FLOWLINE  
 FSE002 STOP END (NOT HANDED)

**MGB 002**

**Classic Gutter Screw on Bracket**

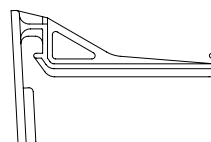

MGB002 4LT SCREW ON GUTTER BRACKET

**MGBC 001** Classic Gutter Eaves Beam Bracket



MGBC001 EAVES BEAM GUTTER BRACKET

**MJB 001** Classic Gutter Joint Bracket

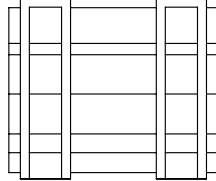

MJB001 GUTTER 4LT JOINT BRACKET

**MGO 001** Special Gutter Outlet/Tank Fitting

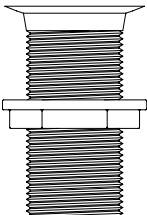

MGO001 SPECIAL GUTTER OUTLET/TANK FITTING (DRILL & FIT)

**MRIA 001** Inline Running Outlet - On Eaves Beam

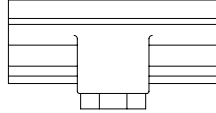

MRIA001 INLINE RUNNING OUTLET (2 X MJB001 REQUIRED)

**MGU - - -** Classic Gutter

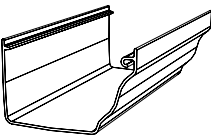

MGU400 GUTTER 4LT 4M

**MRO 001** Running Outlet (Wall Mounted)

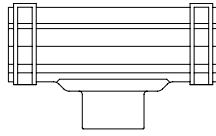

MRO001 RUNNING OUTLET (WALL MOUNTED)

**MGU - - -** Classic Gutter Angle

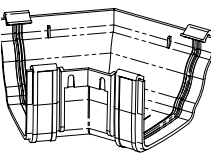

MGU120	GUTTER 4LT 120° ANGLE
MGU125	GUTTER 4LT 125° ANGLE
MGU130	GUTTER 4LT 130° ANGLE
MGU135	GUTTER 4LT 135° ANGLE
MGU135I	GUTTER 4LT 135° INTERNAL ANGLE
MGU140	GUTTER 4LT 140° ANGLE
MGU145	GUTTER 4LT 145° ANGLE
MGU150	GUTTER 4LT 150° ANGLE
MGU155	GUTTER 4LT 155° ANGLE
MGU160	GUTTER 4LT 160° ANGLE
MGU165	GUTTER 4LT 165° ANGLE
MGU170	GUTTER 4LT 170° ANGLE

(FABRICATED VARIABLE ANGLES ARE AVAILABLE)

**MRSA- - -** Stopend Outlet - On Eaves Beam

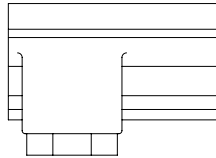

MRSA001 STOPEND OUTLET LEFT  
MRSA002 STOPEND OUTLET RIGHT

**MIA 001** Classic Gutter Internal 90 Degrees

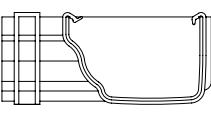

MIA001 GUTTER 4LT INT 90 DEG ANGLE

**MSE - - -** Classic Gutter Stop Ends

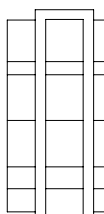

MSE001 GUTTER STOP END LEFT  
MSE002 GUTTER STOP END RIGHT

**MSO - - -** Classic Gutter Stop End Outlet (Wall Mounted)

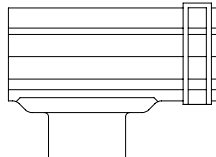

MSO001 GUTTER STOP END OUTLET LEFT  
MSO002 GUTTER STOP END OUTLET RIGHT

**OET 090**

**Trunk Outlet 90°**

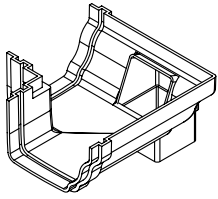

OET090L/R 90° GUTTER TRUNK OUTLET

LEFT (DOWN FRONT LEFT CORNER POST)

MAY ALSO BE USED DOWN SIDE OF FRONT RIGHT CORNER POST (SHOWN). See page 43 for identification of exact needs.

**RWP 250**

**Square Rainwater Pipe**

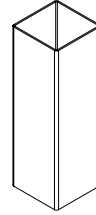

RWP250 RAINWATER PIPE 2.5M

**RDP 068**

**Rainwater Pipe 67° Obtuse Round**

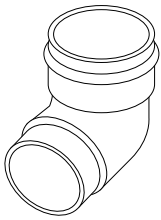

RDP068 PIPE 67° OBTUSE BEND ROUND

**SSGO - - -**

**Trunk Outlet**

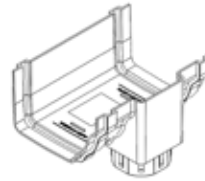

SSG0001 INLINE TRUNK OUTLET  
SSG0002 STOP END TRUNK OUTLET L&R

See page 45 for identification of exact needs.

**RWB 001**

**Offset Bend Kit**

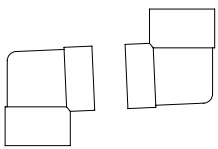

RWB001 OFFSET BEND KIT (SQUARE)

**UZBGSB 001**

**Box Gutter Hanging Bracket**

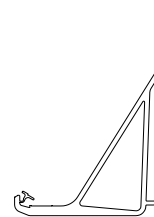

UZBGSB001 BOX GUTTER HANGING BRACKET  
(165MM BOXGUTTER ONLY)

**RWC 001**

**Downpipe Bracket (RWP)**



RWC001 SQUARE DOWNPIPE BRACKET(2)

**UZGU - - -**

**Low Pitch Flowline Gutter**



UZGU--- LOW PITCH FLOWLINE GUTTER

**RWO - - -**

**Rainwater Pipe 67° Obtuse Square**

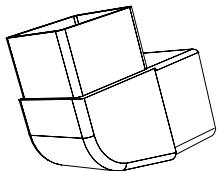

RW0001 PIPE 67 DEG OBTUSE BEND SQUARE  
RW0087 PIPE 87 DEG OBTUSE BEND SQUARE

**UZGU001**

**Low Pitch Flowline Clip on Gutter Bracket**



UZGU001 LOW PITCH FLOWLINE CLIP ON GUTTER BRACKET

**RWP 001**

**Square Rainwater Pipe Branch**

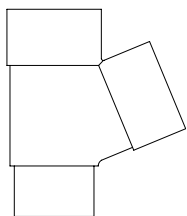

RWP001 RAINWATER PIPE BRANCH

**UZRW 001/1**

**Round Downpipe Bracket Clip**

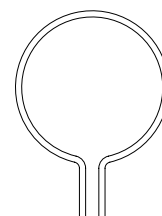

UZRW001/1 DOWNPIPE BRACKET PIPE CLIP  
(CONNECT D.P SHOW TO RWP)

**UZRW 001/2 Round Downpipe Socket Clip**

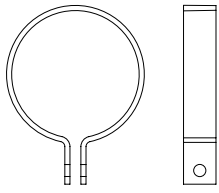

UZRW001/2 DOWNPIPE BRACKET SOCKET CLIP  
(CONNECT RWP TO HOST WALL)

**VWSA - - - 265mm Box Gutter Reinforcement Strap**



VWSA001 265 BOX GUTTER REINFORCEMENT STRAP

**UZRW 001/3 Round Downpipe Bracket Backplate**

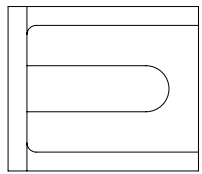

UZRW001/3 DOWNPIPE BRACKET BACKPLATE  
(TO CONNECT SOCKET CLIP TO HOST WALL)

**UZRW 002 Round Downpipe Shoe**

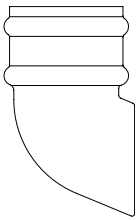

UZRW002 ROUND DOWNPIPE SHOE

**UZRW 250 Round Downpipe**



UZRW250 RAINWATER DOWNPIPE

**VBGB - - - 165mm Box Gutter**

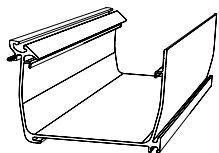

VBGB600PA VICTORIAN 165MM BOXGUTTER ALUMINIUM 6M

**VWBA - - - 265mm Box Gutter**

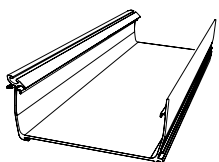

VWBA600/1 265MM BOX GUTTER ALUMINIUM 6M

# SECTION 6 – Ancillaries

Included here are specific roof ancillaries such as the TBRK (Tie Bar Replacement Kit) which make the Classic system the clear winner - tried, tested, trusted.

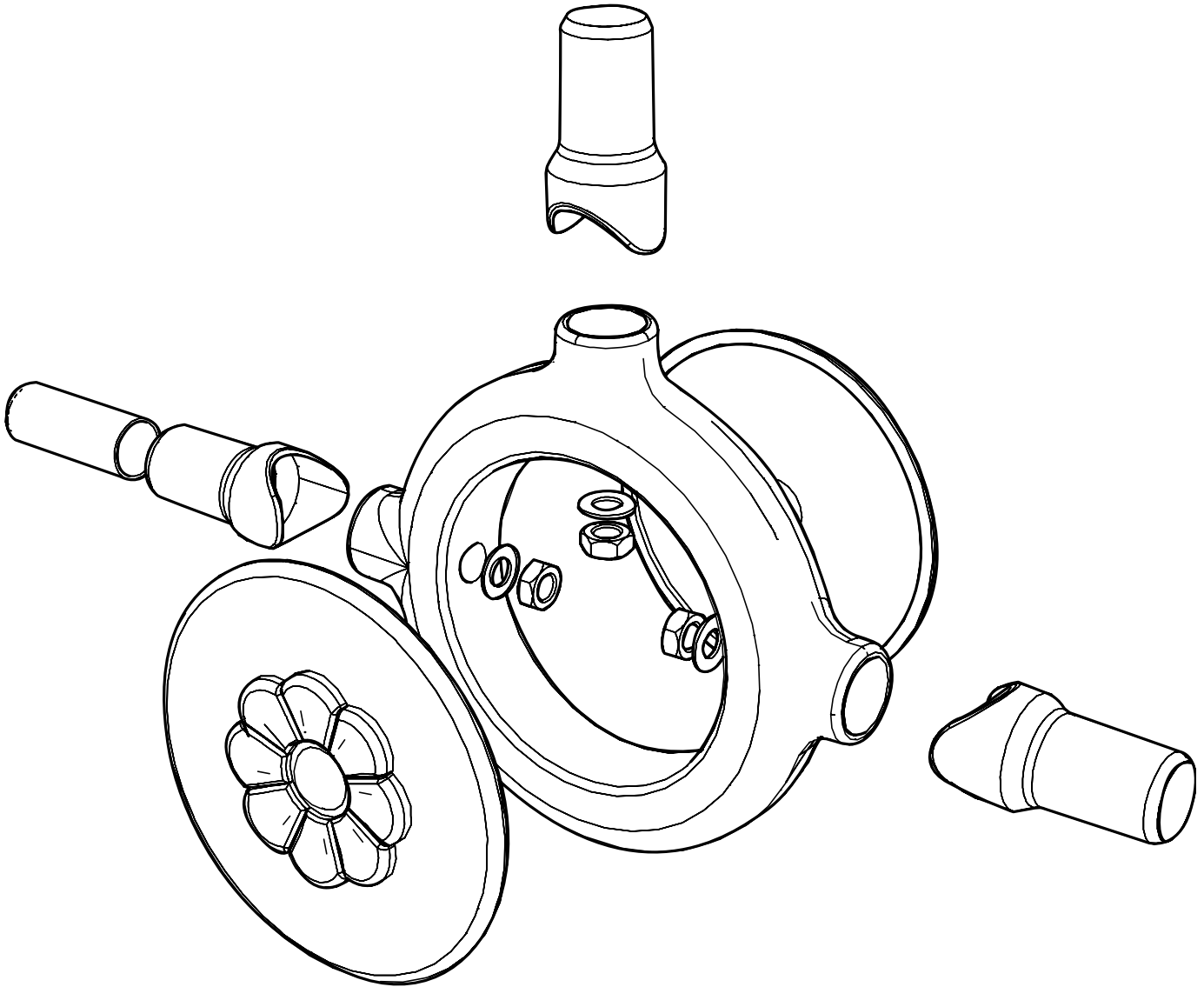

**AMB - - - Aluminium Muntin**

---

AMB--/25	ALUMINIUM MUNTIN
AMB--/32	ALUMINIUM MUNTIN

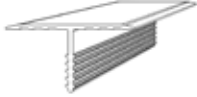

**LFF - - - Conservaflash Horizontal Flashing 570mm**

---

LFF057	HORIZONTAL FLASHING 570MM
LFF090I	INTERNAL 90° CORNER FLASHING

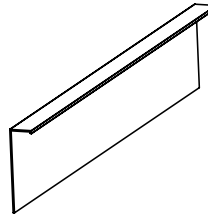

**AVS 001 Roof Vent Motor (Switch)**

---

AVS001	ROOF VENT MOTOR SWITCH
--------	------------------------

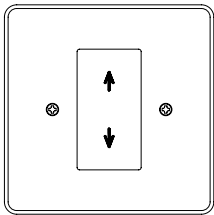

**LFS600 Conservaflash Soaker**

---

LFS600	CONSERVAFLASH SOAKER 6M
--------	-------------------------

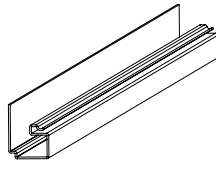

**AVTD 002 Roof Vent Pack (Automatic)**

---

AVTD002	ROOF VENT AUTO PACK INCLUDING THERMOSTAT & RAIN SENSOR
---------	--

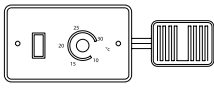

**LPLL - - - Lightboard**

---

LPLL240 FKIT	2.4M LIGHTBOARD
LPLL120 FKIT	1.2M LIGHTBOARD
LPLL240 HKIT	2.4M LIGHTBOARD
LPLL120 HKIT	1.2M LIGHTBOARD

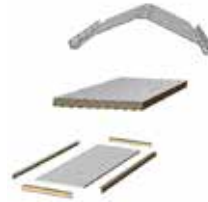

**BRP - - - Opening Pole (Roof Vent)**

---

BRP001T	BRASS POLE TELESCOPIC 2.5M
BRPA001	BRASS POLE (STD)
BRPA001C	CHROME POLE (STD)

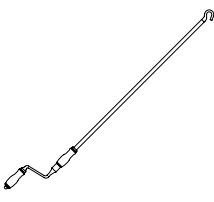

**LVLA 001 Downlights**

---

LVLA001	EYEBALL SPOTLIGHT (BRASS) WITH TRANSFORMER AND WHITE MOUNTING COLLAR
LVLA001B	EYEBALL SPOTLIGHT (BRASS) WITH TRANSFORMER AND BROWN MOUNTING COLLAR
LVLA001CB	EYEBALL SPOTLIGHT (CHROME) WITH TRANSFORMER AND BROWN MOUNTING COLLAR
LVLA001CW	EYEBALL SPOTLIGHT (CHROME) WITH TRANSFORMER AND WHITE MOUNTING COLLAR

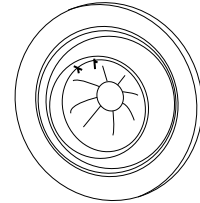

**LFF 001 Conservaflash - Saddle Flashing**

---

LFF001	SADDLE FLASHING
--------	-----------------

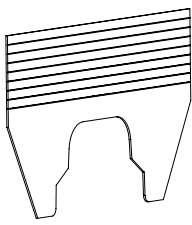

**LFF 001/ Conservaflash - Stepped Units**

---

LFF001/15L/R	L/R STEPPED UNITS 10-15.9°
LFF001/20L/R	L/R STEPPED UNITS 16-20.9°
LFF001/25L/R	L/R STEPPED UNITS 21-25.9°
LFF001/30L/R	L/R STEPPED UNITS 26-30.9°
LFF001/35L/R	L/R STEPPED UNITS 31-35°

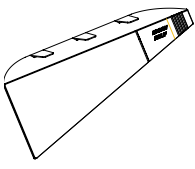

**NCGS - - - Sealant**

---

NCGS001B	MS POLYMER SEALANT
----------	--------------------

(MUST BE USED ON SELF CLEAN GLASS)



**PMB 001**

**Muntin Bar**

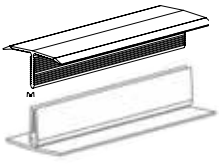

PMB300/1 MUNTIN BAR (ADJOINING SEALED UNITS ONLY) TOP SECTION

PMB300/2 BOTTOM SECTION

**SLCCU003**

**Radio Control Unit**



SLCCU003 RADIO CONTROL UNIT

**Q8750**

**Roof Vent Motor (Actuator)**

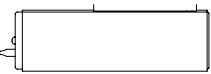

Q8750 ROOF VENT MOTOR (ACTUATOR WHITE)

QBL8750 ROOF VENT MOTOR (ACTUATOR BLACK)

**SLRCU003RC**

**Remote Wireless Transmitter**



SLRCU003RC REMOTE WIRELESS TRANSMITTER (FOR SLCC003)

**RVSA - - -**

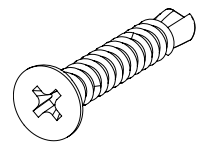

RVSA002 BOLSTER SCREW 4.8 X 32  
RVSA013 RE-INFORCING SCREW M4 X 13

**SLVSP- - -**

**Slimline Vent Spindle Kit**

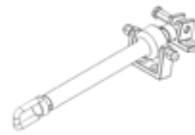

SLVSP001CH SLIMLINE VENT SPINDLE KIT (CHROME)  
SLVSP001BR SLIMLINE VENT SPINDLE KIT (BRASS)  
SLVSP001CH FIXINGS KIT (CHROME)  
SLVSP001BR FIXINGS KIT (BRASS)

**RRC 004**

**M10 Full Nut**



RRC004 M10 FULL NUT

**TBBC001/1**

**Tie Bar Bracket**



TBBC001/1 TIE BAR BRACKET

**SHBC 001**

**Square Head Bolt**



SHBC001 SQUARE HEAD BOLT

**TBBC001/2**

**Tie Bar Bracket Cover**



TBBC001/1 TIE BAR BRACKET COVERS

**SLCCU002**

**Thermostat & Rain Sensor**



SLCCU002 ELECTRIC THERMOSTAT & RAIN SENSOR

**TBC - - -**

**Tie Bar Conduit**

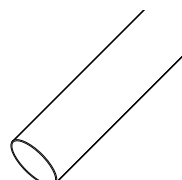

TBC200 TIE BAR CONDUIT 2M  
TBC300 TIE BAR CONDUIT 3M



**TBPB001**      **Pivot Bush**

---

TBPB001      PIVOT BUSH



**TFKD - - -**      **Tie Bar Fixing Kit**

---

TFKD003      3 WAY TIE BAR FIXING KIT

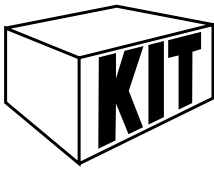

**TFSA 001**      **Tie Bar Bracket Bolt**

---

TFSA001      TIE BAR BRACKET BOLT 24MM AND NUT

(USED ONLY WHEN 7 SERIES BAR IS REINFORCED)

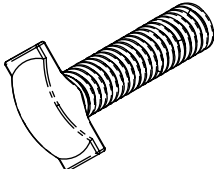

**THD 001**      **T Bar Spanner**

---

THD001      10MM T BAR SPANNER  
 THD002      13MM T BAR SPANNER



**TTB - - -**      **Tie Bar Threaded Bar**

---

TTB200      TIE BAR THREADED BAR 2M  
 TTB300      TIE BAR THREADED BAR 3M

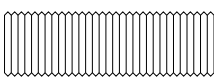

**SECTION 7** - Marley Classic Box Gutter Adaptors

**165mm**

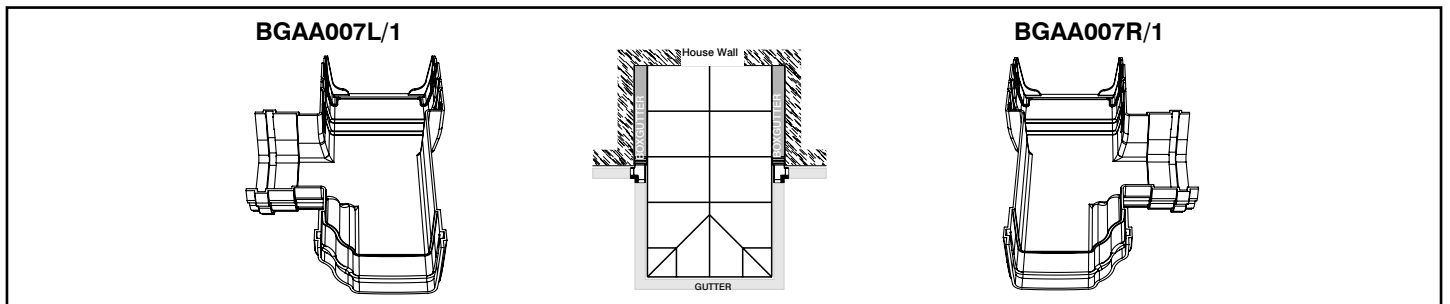
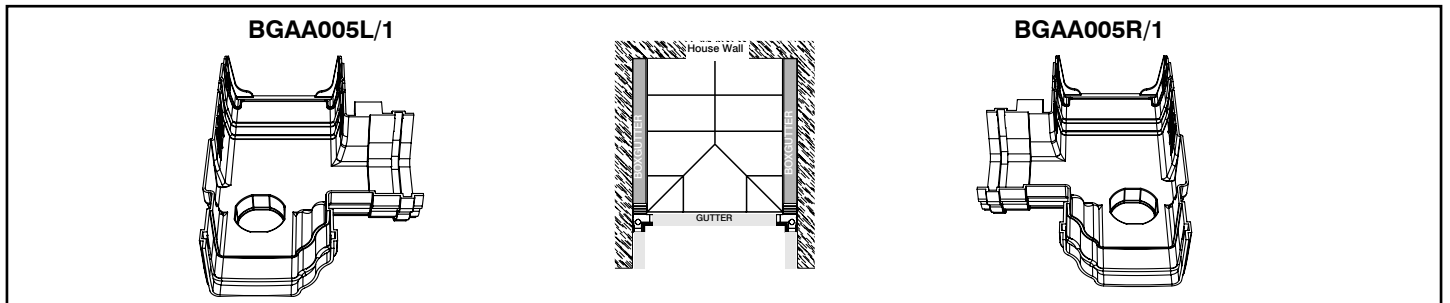
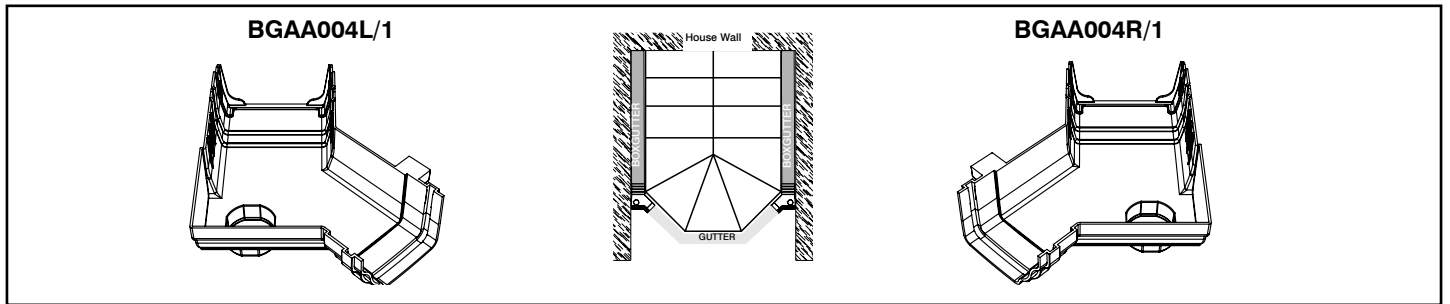
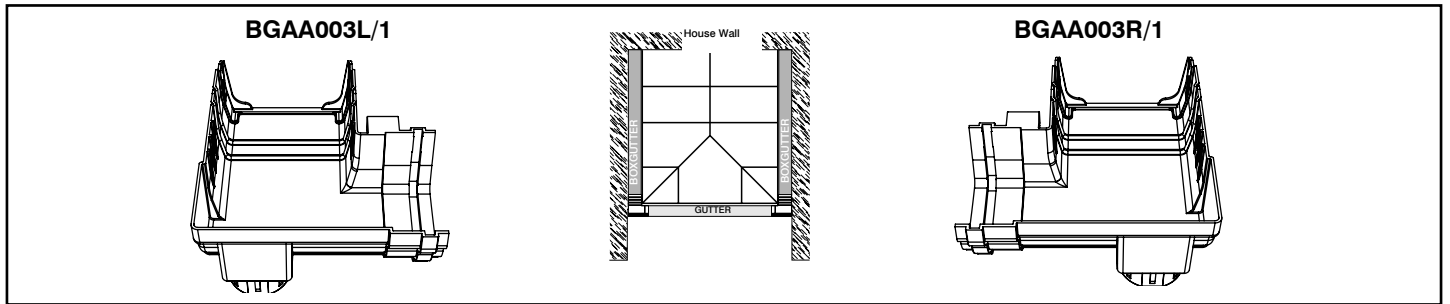
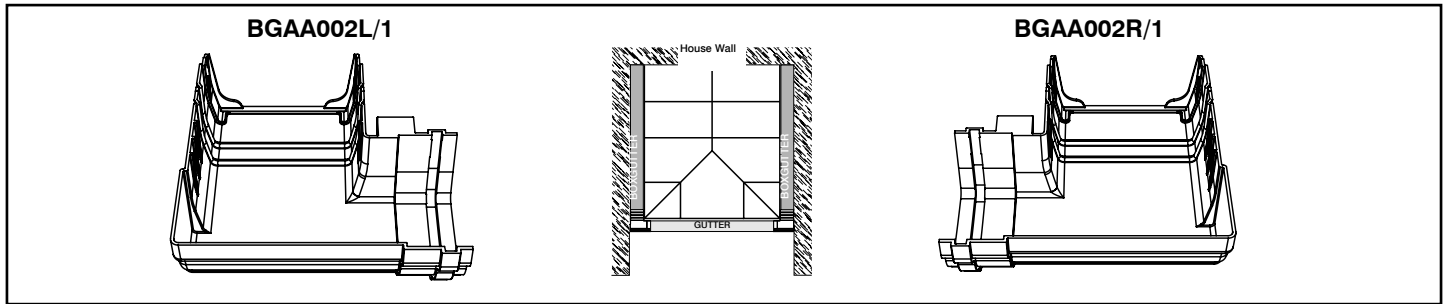
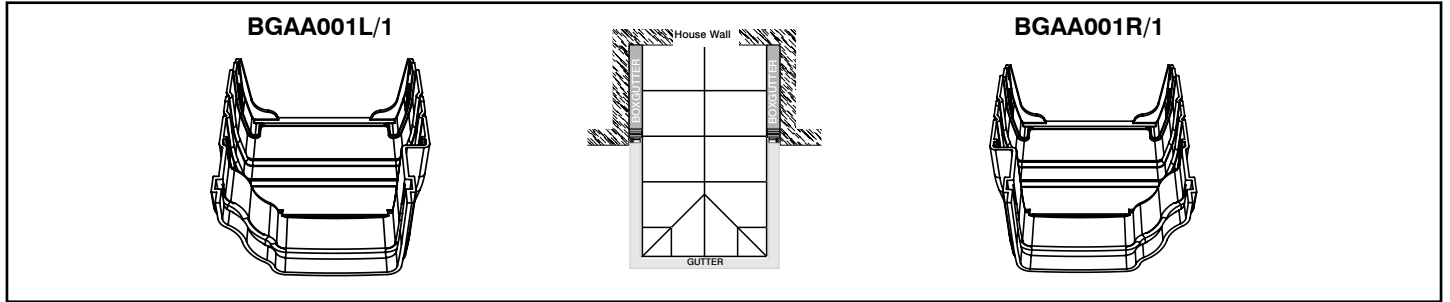

265mm

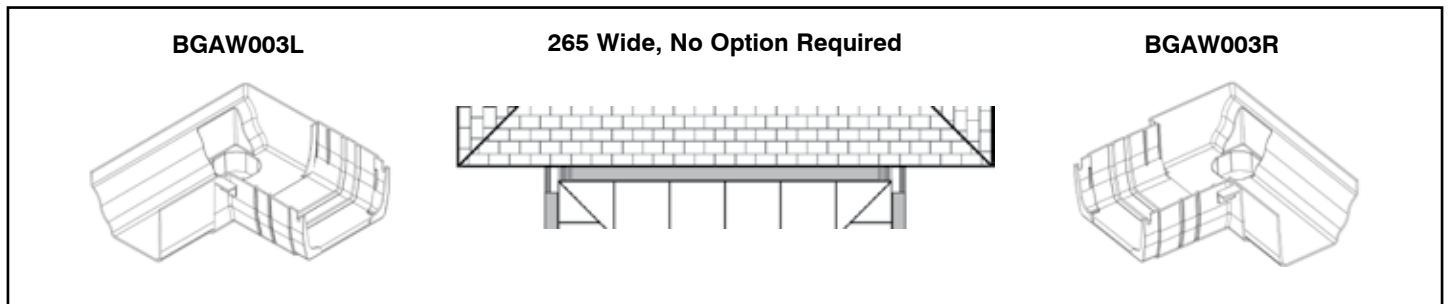
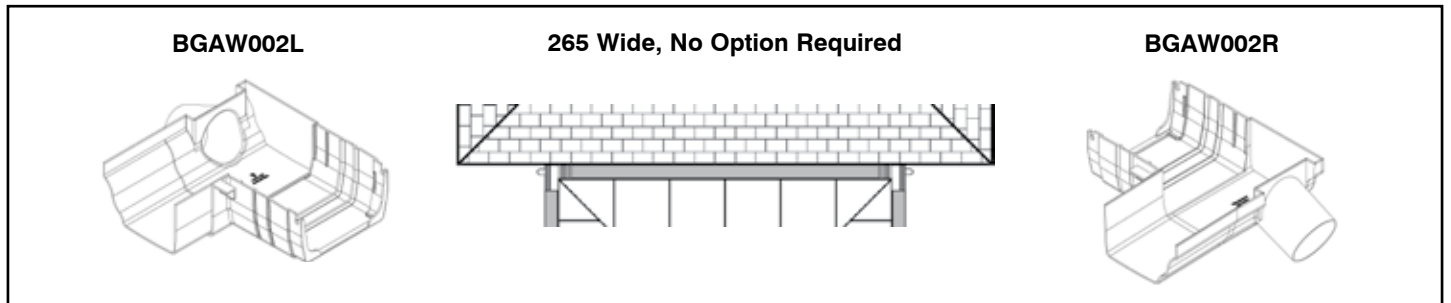
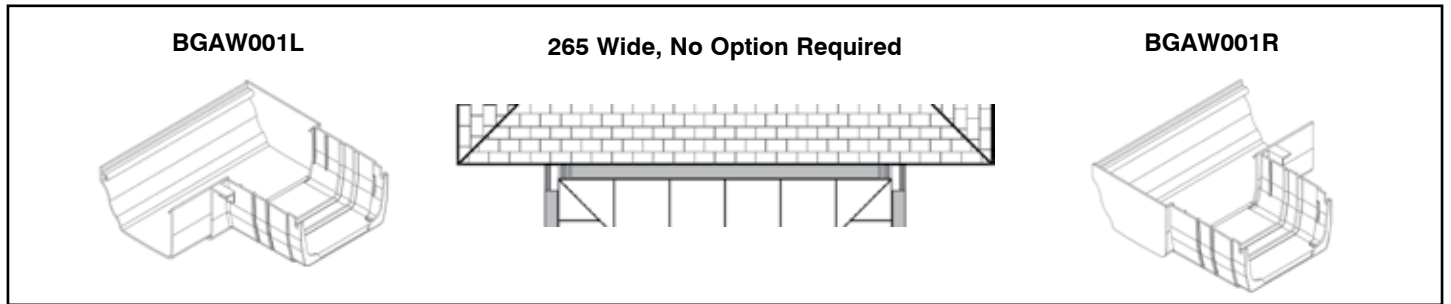
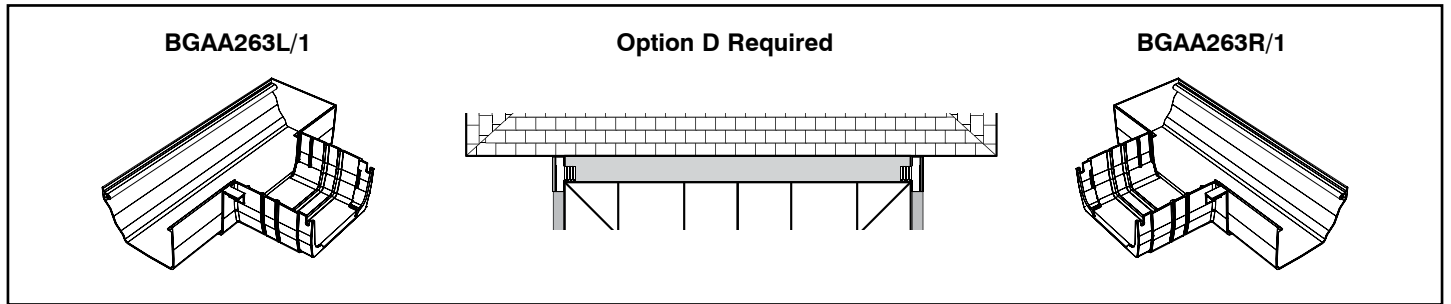
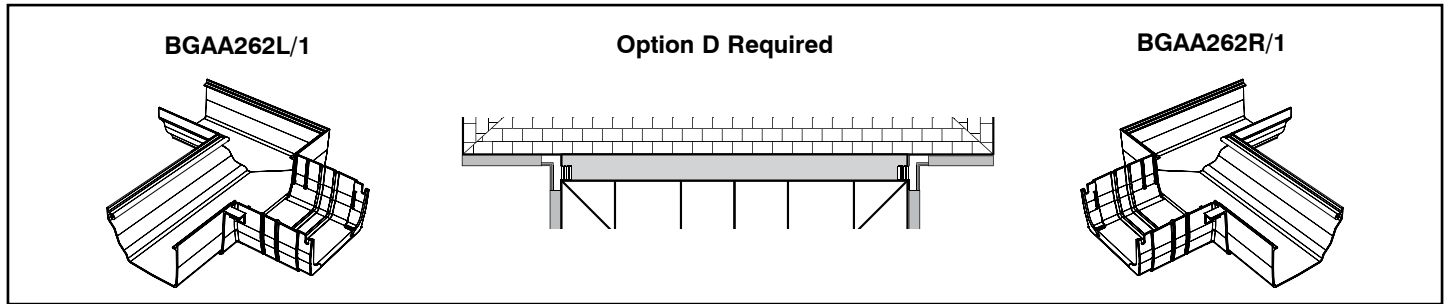
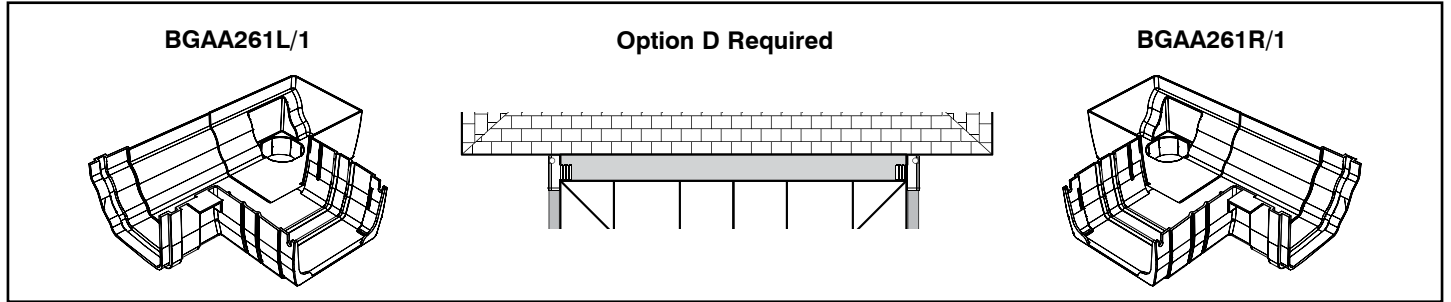

## SECTION 7 - Marley Classic Box Gutter Adaptors

**BGAE001L**

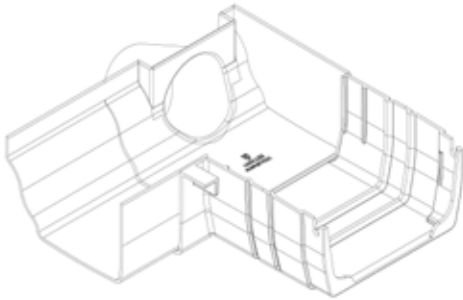

To suit  
165mm wide

**BGAE001R**

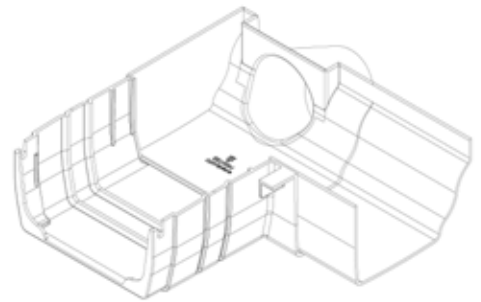

**BGAE263L**

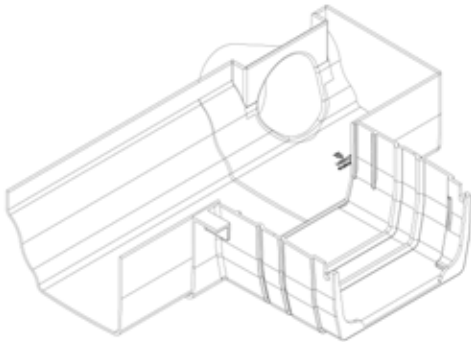

To suit  
265mm wide  
with option D reducer

**BGAE263R**

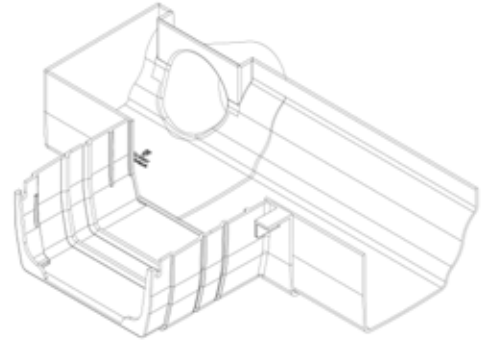

**BGSE001L**

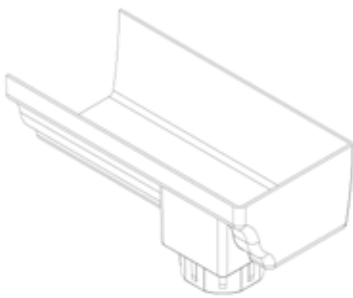

To suit 165mm or 175mm wide  
sofit box gutter  
or  
to suit 275mm wide sofit box gutter  
with reverse option A reducer  
or  
to suit 265mm wide box gutter  
with option A reducer

**BGSE001R**

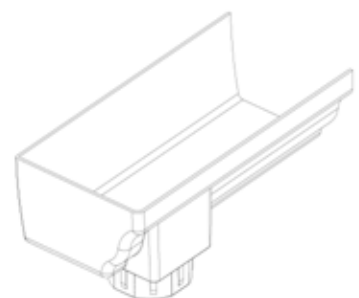

**LEFT HAND**

**RIGHT HAND**

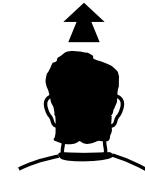
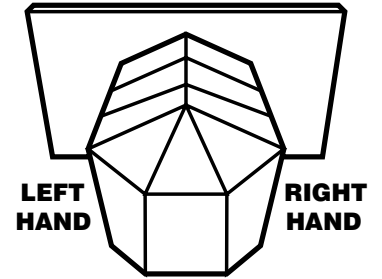
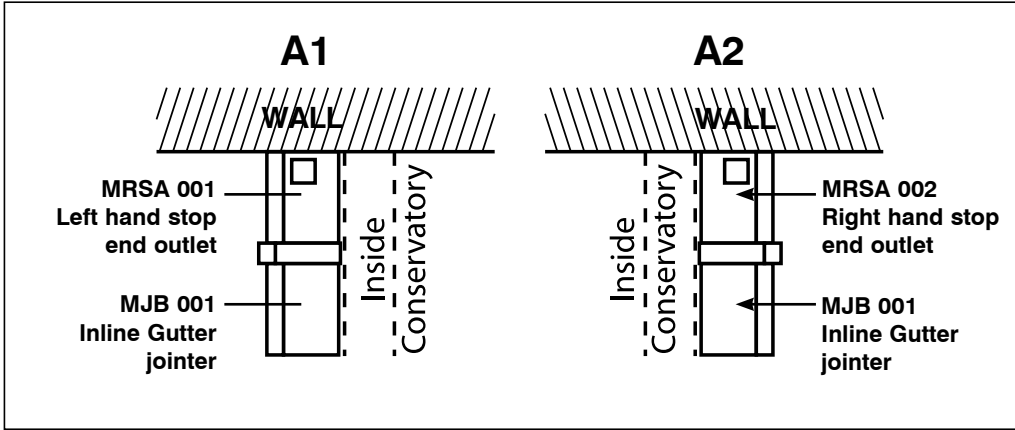

REMEMBER- MARLEY CLASSIC GUTTER IS 'HANDED'

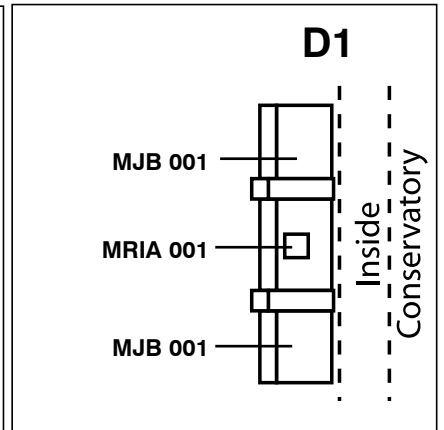
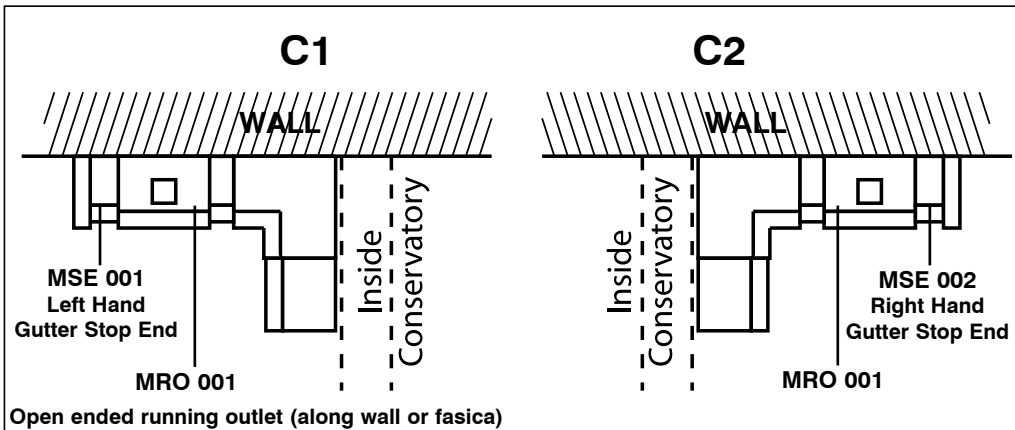
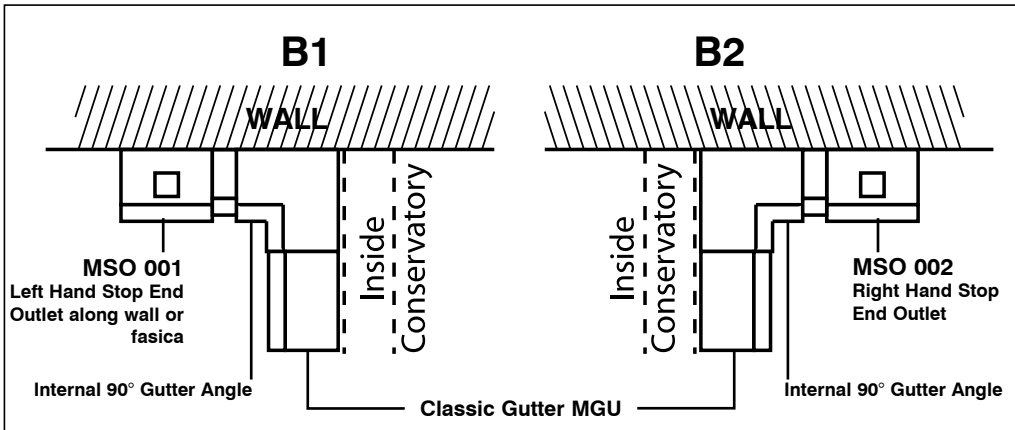

**ELEPHANT'S TRUNKS**

SSGO 002L

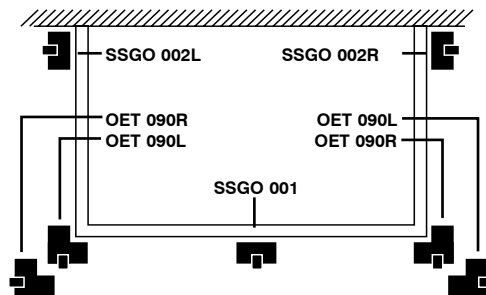
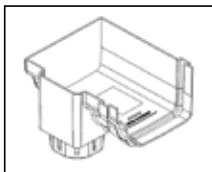

SSGO 002R

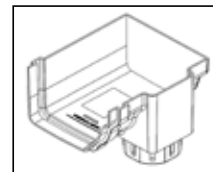

OET 090L

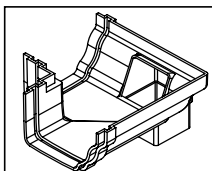

SSGO 001

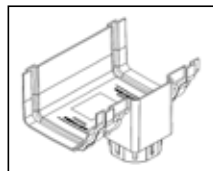

OET 090R

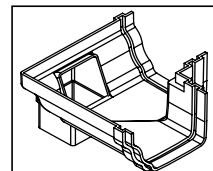

[www.ultraframetrade.co.uk](http://www.ultraframetrade.co.uk)

**Job No.: 2697 01/20 V7**

It is Ultraframe's policy to continually seek to improve its products, processes and services, and we reserve the right to change specifications without prior notice. Ultraframe is a trading name of Ultraframe (UK) Limited.

Ultraframe<sup>®</sup>